

Operation Instruction

SR81Q

Intelligent Controller

for Split Pressurized Solar Hot Water System



Please read this instruction carefully!

Contents

1. Safety information	3
1.1 Installation and commissioning	3
1.2 About this manual	3
1.3 Liability waiver	3
1.4 Important information	4
1.5 Signal description	4
1.6 Button and HMI description	4
2 Overview	5
2.1 Technical data	5
2.2 Delivery list	6
3. Installation	6
3.1 Mounting the display of controller	7
3.2 Mounting the board of controller	7
3.3 Preparation before wiring connection	7
3.4 Wiring connection	7
3.5 Terminal connection	8
3.6 R3 output connection with T- valve / pump	10
3.7 Connection with high efficiency pump	10
4. System description (Standard solar system with 1 tank, 1 collector field)	12
5. Time setup	13
6. Function's parameters and options	14
6.1 Overview of menu structure	14
6.2 Menu operation description	14
6.3 Value checking and function checking	15
7. Functions operation and parameters setting (for user)	16
7.1 THET Timing heating	16
7.2 CIRC DHW circulation pump controlled by temperature and time	19
8. Function operation and parameter setup (engineer)	24
8.1 PWD Password	24
8.2 LOAD tank heating	25
8.3 COL Collector function	28
8.4 PUMP Pump control mode	33

8.5 COOL Cooling function	36
8.6 AUX Auxiliary function	40
8.7 MAN Manual operation	44
8.8 BLPR Blocking protection	45
8.9 OTDI Thermal Sterilization Function.....	46
8.10 OPAR Parallel relays	47
8.11 OHQM Thermal energy measuring.....	48
8.12 FS Flow meter option and flow rate monitoring	52
8.13 UNIT Switch	54
8.14 RET Reset.....	55
8.15 PASS Password set	56
8.16 Manual heating.....	57
8.17 ECO Economic mode.....	57
8.18 DHW circuit pump triggered manually	58
8.19 On/Off controller	58
8.20 Holiday function.....	58
8.21 Manual circuit function	58
9. Protection function.....	59
9.1 Memory function during power failure.....	59
9.2 Screen protection	59
10 Trouble checking	59
11. Quality Guarantee	61
12. Accessories	61

1. Safety information

1.1 Installation and commissioning

- When laying wires, please ensure that no damage occurs to any of the constructional fire safety measures presented in the building.
- The controller must not be installed in rooms where easily inflammable gas mixtures are present or may occur.
- The permissible environmental conditions can't be exceeded at the site of installation.
- Before connecting the device, make sure that the energy supply matches the specifications that controller requires.
- All devices connected to the controller must conform to the technical specifications of the controller.
- All operations on an open controller are only to be conducted cleared from the power supply. All safety regulations for working on the power supply are valid.
- Connecting and /or all operations that require opening the collector (e.g. changing the fuse) are only conducted by specialists.

1.2 About this manual

This manual describes the mounting, functions and operation of a solar controller used for a solar hot water system, for mounting of other devices of a completed solar hot water system like solar collector, pump station and storage, please is sure to observe the appropriate installation instructions provided by each manufacturer. Mounting, wire connecting, commissioning and maintenance of this controller may only be performed by the trained professional person; the professional person should be familiar with this manual and follow the instructions contained herein.

1.3 Liability waiver

The manufacturer can't monitor the compliance with these instructions or the circumstances and methods used for installation, operation, utilization and maintenance of this controller. Improper installation can cause damages to material and person. This is the reason why we do not take over responsibility and liability for losses, damages or cost that might arise due to the improper installation, operation or wrong utilization and maintenance or that occurs in some connection with the aforementioned. Moreover we do not take over liability for patent infringements or infringements – occurring in connection with the use of this controller on the third parties rights. The manufacturer preserves the right to put changes to product, technical data or installation and operation instructions without prior notice. As soon as it becomes

evident that safe operation is no longer possible (e.g. visible damage). Please immediately take the device out of operation. Note: ensure that the device can't be accidentally placed into operation.

1.4 Important information

We have carefully checked the text and pictures of this manual and provided the best of our knowledge and ideas, however inevitable errors may exist. Please note that we cannot guarantee that this manual is given in the integrity of image and text, incorrect, incomplete and erroneous information and the resulting damage we do not take responsibility.

1.5 Signal description



Safety indication: Safety instructions in the text are marked with a warning triangle.

They indicate measures which can lead to injury of person or safety risks.

Operation steps: small triangle "▶" is used to indicate operation step.







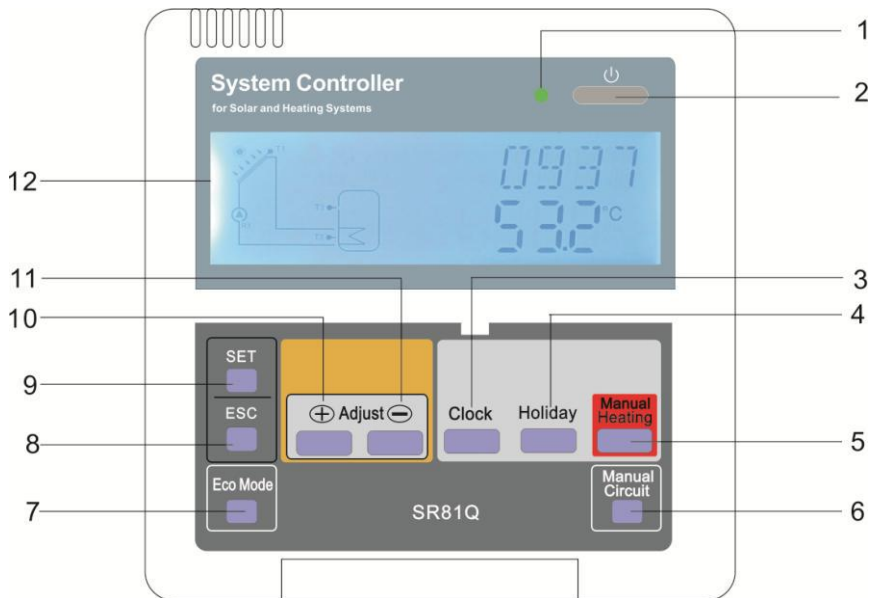



Note: contains important information about operation or functions.

1.6 Button and HMI description



Nr.	Button
1	Power indication lamp
2	"On/Off"
3	"Clock"
4	"Holiday"
5	"Manual Heating"
6	"Manual Circuit"
7	"Eco Mode"
8	"ESC"
9	"SET"
10	Upwards adjust "+"
11	Downwards adjust "-"
12	LCD Display screen

Status Description	Code	Lighting	Blinking
Exceed the maximum temperature of storage	SMX		
Running of storage emergency shutdown function			
Running of collector emergency shutdown function	OCEM		 + 
Running of collector cooling	OCCO		
Running of tank cooling function	OSTC		
Start of anti-freezing function	OCFR		
Running of anti-freezing function	OCFR		

2 Overview

2.1 Technical data

- **Input:**
 - 1* Pt1000 temperature sensor
 - 5* NTC10K, B=3950 temperature sensor
 - 1* Grundfos Direct Sensor TM (VFS) analog input
 - 1* FRT digital flow meter
- **Output:**

- 1 * Semiconductor relay, Max current: 1A
- 2 * Electromagnetic relay, Max. Current: 2A
- 1 * Electromagnetic relay, Max. Current: 10A
- 1 * Low voltage relay for linkage with HR (on/off signal)
- 1* PWM frequency control output (0-10V)
- **Function:** running time accumulation, tube collector function, timing heating function, pump speed control, thermal energy measuring, external heat exchanger, system parameters adjust, optional function adjust (menu), balance and diagnose function.
- **Power supply:** AC100...240V ~ (50...60Hz)
- **Rated impulse voltage:** 2.5KV
- **Housing:** Plastic ABS
- **Mounting:** Wall mounting
- **Operation:** 10 push buttons at the front cover
- **Protection type:** IP40
- **Dimension of display:** 120*120*18mm
- **Dimension of controller board:** 200*140*43mm



Note: there are 5 inputs for NTC10K, B=3950 temperature sensor, but only 4 sensors are included in the standard delivery list; the other one should be purchased separately by customer if necessary.

2.2 Delivery list

- 1 * SR81Q controller
- 1 * accessory bag
- 1 * user manual
- 1 * PT1000 temperature sensor ($\phi 6 \times 50$ mm, cable length 1.5meter)
- 4 * NTC10K temperature sensor ($\phi 6 \times 50$ mm, cable length 3meter)
- 1 * 10A power cable

3. Installation



Note: The unit must only be located in the dry interior rooms. Please separate routing of sensor wires and mains wires. Make sure the controller as well as the system is not exposed to strong electromagnetic fields.

3.1 Mounting the display of controller

- ▶ Using Screw and turn it, take the display base plate out, see picture 1
- ▶ Fixing the base on the wall with screw (see picture 2), (Note: don't drill hole on the base plate)
- ▶ Insert the display into the base plate groove ①②, and press it tightly. See picture 3



3.2 Mounting the board of controller

Follow the below steps to mount the controller on the wall.

- ▶ Select the proper place to install main board of controller
- ▶ Put the hung housing plate on the wall and mark the upper fastening point.
- ▶ Drill the holes and put the plastic expansion bolt into the holes.
- ▶ Hang the housing plate on the screw and fasten it
- ▶ Hang the controller on the housing plate.

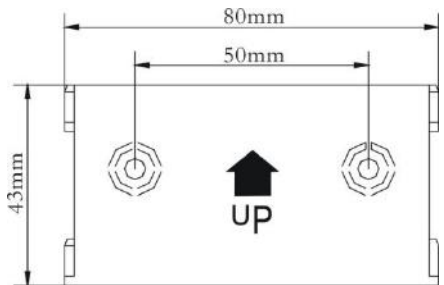

3.3 Preparation before wiring connection

Open/close the cover of connection terminal.

- ▶ Unscrew the screw ①②, and take out the cover upwards
- ▶ Close the cover: close the cover downwards
- ▶ Fix the cover with the screw ①②

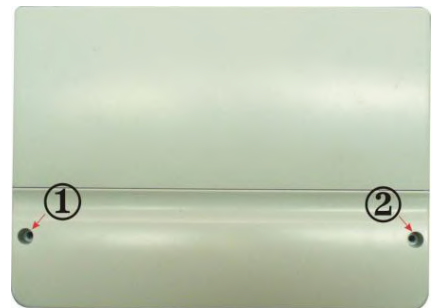

3.4 Wiring connection



Note: Power can only be switched-on when the controller housing is closed. Installer should be sure that the IP safety protection grade of controller isn't damaged during installation.

According to the way of installation, wire can be connected from hole ④ on the bottom plate

or from hole ⑤, using a suitable tool (like knife) to cut the plastic of ⑤, and wire is connected into housing from hole ⑤.

i Note: wires must be fastened by fixing clamps on the position ⑥.

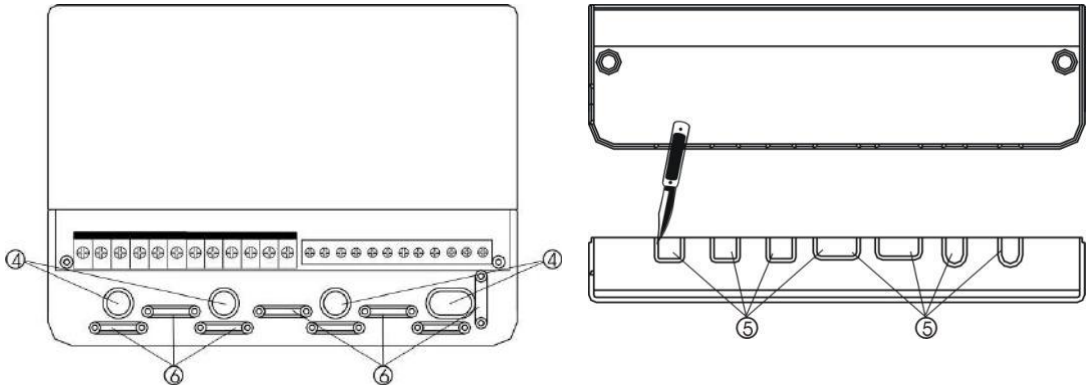

3.5 Terminal connection

! **Note:** before opening the housing! Always disconnect the controller from power supply and obey the local electrical supply regulation.

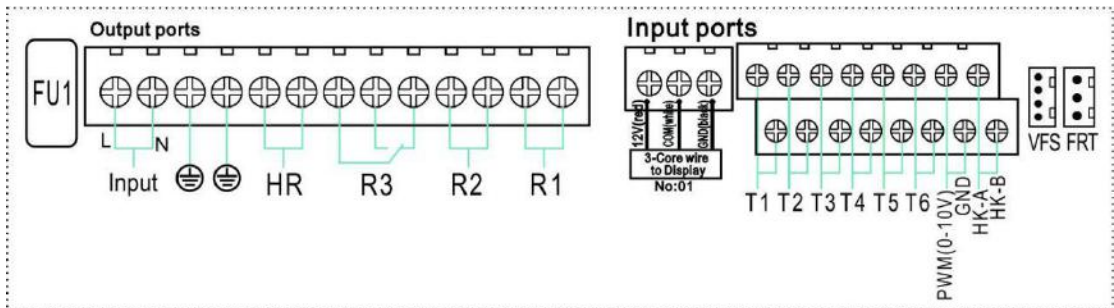

● Input ports

- T1: PT1000 temperature sensor, for measuring the temperature of collector
- T2 ~T6: NTC10K, B=3950 temperature sensor, for measuring temperature of tank and pipe.
- HK-A, HK-B: on/off signal, (HK and HR triggered or stopped synchronously, for boiler heating controller)
- PWM: for high efficiency pump, connection see pump terminal connection diagram
- VFS: connect Grundfos flow sensor
- FRT: For rotary vane type electronic flowmeter

- **Output ports**

- Input Ports L, N: for power connection, L: live wire, N: zero wire,  protective wire, with 10A power plug.

- Output R1: semiconductor relay, Max. Current: 1A

- Output R2: Electromagnetic relay, Max. Current: 2A

- Output R3: Electromagnetic relay, Max. Current: 2A

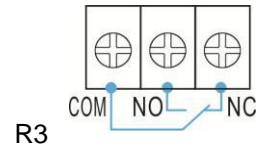

- **Output HR: Electromagnetic relay, designed for on/off control of back-up heating device, Max. Current: 10A (@AC230V, for $\leq 1500W$ electrical heater, @110VAC, for $\leq 750W$ electrical heater)**

- **Advice regarding the installation of temperature sensors:**

- Only original factory equipped Pt1000 temperature sensors are approved for using with the controller, it is equipped with 1.5m silicon cable and suitable for all weather conditions, the cable is temperature resistant up to 280°C, connect the temperature sensors to the corresponding terminals with either polarity.

- Only original factory equipped NTC10K,B=3950 temperature sensors are approved for using with tank and pipe, it is equipped with 3m PVC cable, and the cable is temperature resistant up to 105°C, connect the temperature sensors to the corresponding terminals with either polarity.

- All sensor cables carry low voltage, and to avoid inductive effects, must not be laid close to 230 volt or 400 volt cables (minimum separation of 100mm).

- If external inductive effects are existed, e.g. from heavy current cables, overhead train cables, transformer substations, radio and television devices, amateur radio stations, microwave devices etc., then the cables to the sensors must be adequately shielded.

- Sensor cables may be extended to a maximum length of ca. 100 meter, when cable's length is up to 50m, and then 0.75mm² cable should be used. When cable's length is up to 100m, and then 1.5mm² cables should be used.

3.6 R3 output connection with T- valve / pump

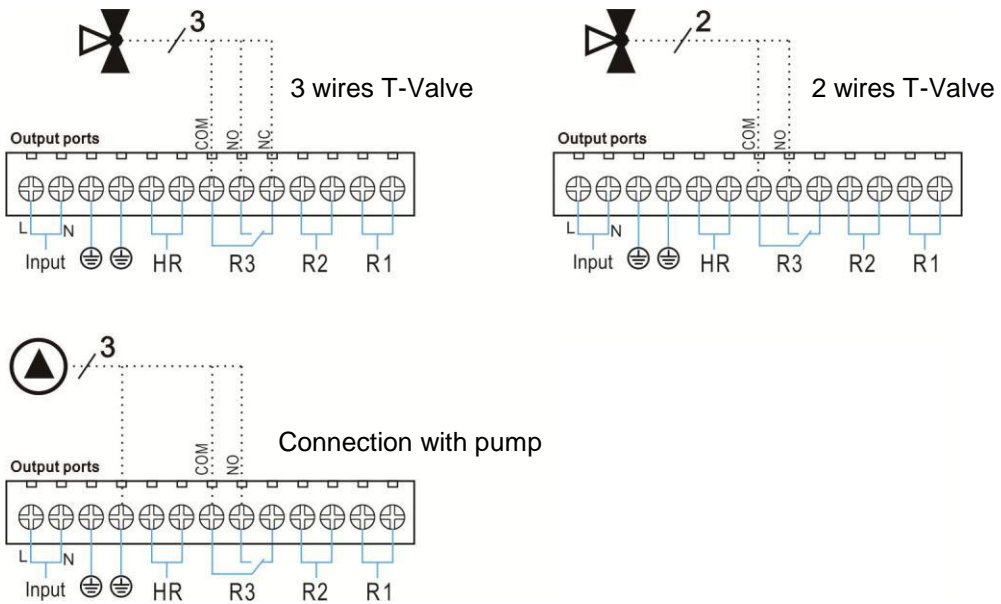

R3 connect with T-valve: (COM common terminal, NO always open terminal, NC always close terminal)

R3 connect with pump: (COM common terminal, NO always open terminal)

3.7 Connection with high efficiency pump

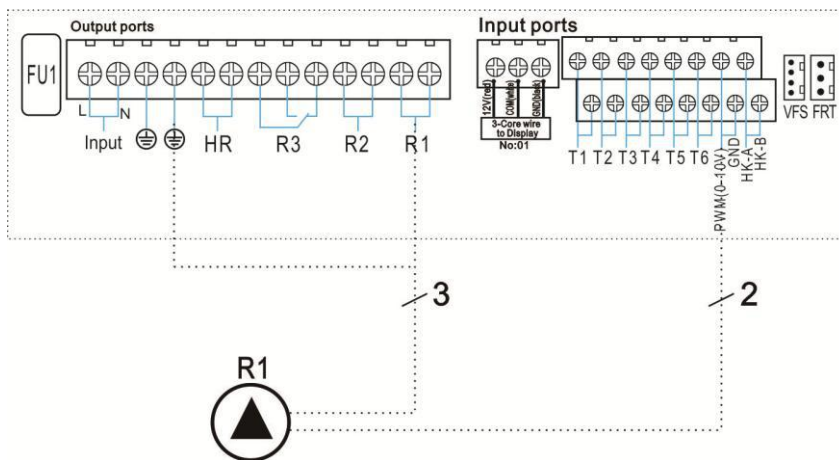

● Wire connection with high efficiency pump

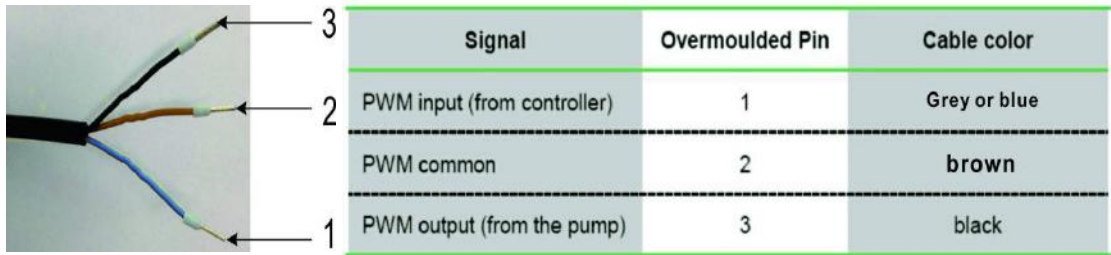

Signal wire 1 of high efficiency pump is connected with GND terminal of controller

Signal wire 2 of high efficiency pump is connected with PWM terminal of controller

Signal wire 3 of high efficiency pump is not connected with controller

Some pumps connections are available as above, for example:

Wilo Yonos PARA ST15/7.0 PWM2 M

Grundfos UPM3 SOLAR 15-75 130 CZA

Note:

1. High-efficiency pump with 0-10V signal only has 2 signal wires, connected to the corresponding port GND, PWM1 of controller.
2. Blue wire not always represent for “GND” and brown wire not always represent for “PWM”.
 - ”PWM” from pump must be match for “PWM” from controller.
 - ”GND” from pump must be match for “GND” from controller.

4. System description (Standard solar system with 1 tank, 1 collector field)

Description:

The controller calculates the temperature difference between collector sensor T1 and tank sensor T2. If the difference is larger than or identical to the adjusted switch-on temperature difference, the solar circulation pump (R1) will be switched on and the tank will be loaded until the switch-off temperature difference or the maximum tank temperature is reached.

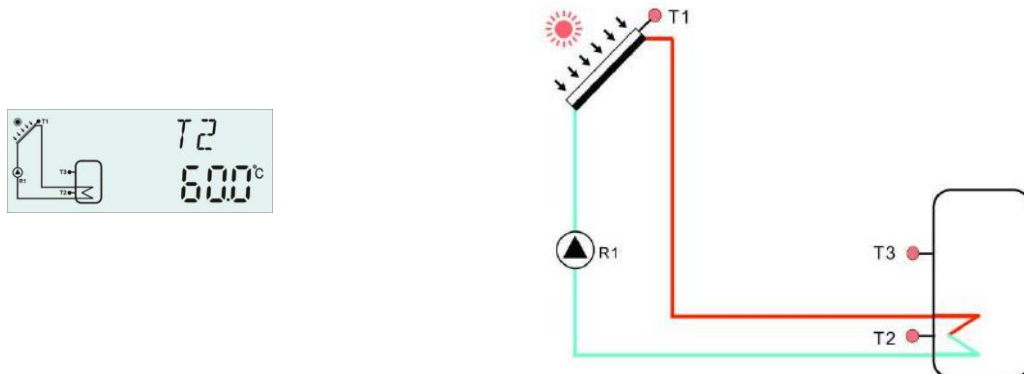

Sensor ports	Description	Relay outputs	Description
T1	Collector temperature sensor PT1000	R1	For solar circuit pump
T2	Temperature sensor on the bottom part of tank. NTC10K	HR	For back-up heating
T3	Temperature sensor on the upper part of tank. NTC10K		
T5	Flow temperature sensor(For thermal energy measurement)		
T6	Return temperature sensor(For thermal energy measurement)		

Auxiliary functions

Function code	Function description	Sensor	Relay output
CIRC	DHW circulation (controlled by temperature or flow impulse)	T4/flow switcher (connected on T6 port)	R2
OHDP	Thermal transfer -by external radiator		R2/R3 optional

TIMER	Timer function		R3
AH	Thermostat function	T2/T3/T5 optional	R3

i **Note:** Functions AH, TIME, OPAR all are designed to use output R3, when one of these three functions (AH, TIME, OPAR) is activated, and then the other two will be deactivated automatically.

5. Time setup



Before switch-on the power, please connect sensor on the inputs terminal, connect pump or on/off valve on the outputs terminal. After the power is switched-on, you can set the time, password and parameters of system.

- ▶ Press “Clock” button, Time displays on the screen, hour “00” blinks on the display.
- ▶ Press “+/-” button, to adjust hour
- ▶ Press “Clock” button again, minute time “00” blinks on the display
- ▶ Press “+/-” button to adjust minute
- ▶ Press “ESC” button to save the set value



i **Note:** In the case that power to controller is switched-off, date and time will be memorized in controller for 36 hours.

6. Function's parameters and options

6.1 Overview of menu structure

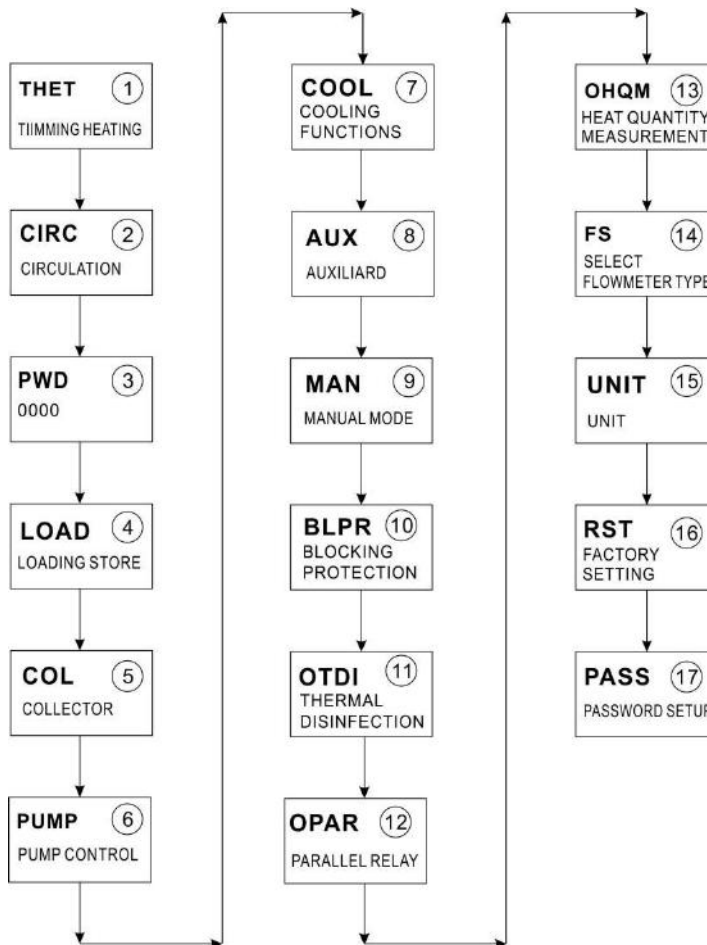

6.2 Menu operation description

- **Access main menu**

- ▶ Press “SET” button to access main menu
- ▶ Press “+/-” to select menu
- ▶ Press “SET” button to enter the submenu

- **Access submenu**

- ▶ After selecting main menu, then press “SET” button to access submenu
- ▶ Press “+/-” button to select submenu,



- ▶ Press “SET” button to enter the value adjust window or function selection window
- ▶ Press “+/-” to adjust value
- ▶ Press “SET” or “ESC” to confirm the value you set
- ▶ Press “ESC”, exit the submenu.

i **Note:** Enter the menu adjustment interface, if you don't press any button within 3 minutes, screen will exit the adjustment and turn to main interface.

6.3 Value checking and function checking

At the normal operation mode, press “+/-” button, you can view the temperature of collector and tank, pump speed (n1%), accumulation running time of circuit pump (hR1), daily thermal energy (DKWh), accumulation thermal energy (kWh or MWh), flow rate (L/M), controller running time (DAYS), software version (SW).



Under the checking status, when digital flow meter (FRT) is out of work, (L/M, 0.0) is displayed on the screen, you can quickly switch off digital flow meter FRT, doing like below steps:

- ▶ Press “+/-” button, select flow rate, (L/M 0.0) appears
- ▶ Press “SET” for 3 seconds, beeper makes a sound “du.....” 3 times, and then press “ESC” button, to switch off the digital flow meter.

i **Note:**

- Flow rate display, sterilization function, auxiliary function and parallel relays function can only be displayed only when the function is activated.
- When sterilization function is running, sterilization time can be checked, when auxiliary function is running, corresponding signal blinks on the screen
- SW: screen version, SW-M: controller version
- DAYS: running time of display, MDAY: running time of controller
- Thermal energy is showed as kWh under kWh channel, is showed as MWh under MWh channel, total accumulation of thermal energy produced by solar system is the plus of kWh + MWh
- Enter the value check interface, if you don't press any button within 3 minutes, screen will exit the check interface and turn to main interface.

7. Functions operation and parameters setting (for user)

7.1 THET Timing heating

Function description:

Electrical heater or gas / oil boiler is normally used as back-up heating source of a solar hot water system. Through this timing heating function controller can keep the tank temperature constantly. When tank temperature (T3) drops below the switch-on thermostats temperature, back-up heating output HR is triggered, when T3 rises up to the switch-off thermostats temperature, HR is ceased.

● Set time sections and temperature for timing heating daily

Factory set:

- ◇ The first time section: default at 4:00 to start heating, and at 5:00 to stop heating, and the switch-on temperature of heating is 40°C, switch-off temperature is 50°C。
- ◇ The second time section: default at 10:00 to start heating, and at 10:00 to stop heating, and the switch-on temperature of heating is 50°C, switch-off temperature is 55°C。
- ◇ The Third time section: default at 17:00 to start heating, and at 22:00 to stop heating, and the switch-on temperature of heating is 50°C, switch-off temperature is 55°C。

If you set the start time and close time with a same value, which means within this time section, the timing heating function is switched-off. For example, at the second time section, start time is set at 10:00, but close time is also set at 10:00.

Timing heating function is run at the preset time section, 3 time sections can be set, and within every time section, the desired temperature may be different. The adjustable range of switch-on temperature is 0°C ~ (OFF-2°C), switch-off temperature range is (ON+2°C) ~ 95°C.

● SMT Intelligent heating

At the case that solar energy is insufficient to heat the tank, in order to ensure user has sufficient hot water, controller will check the temperature of tank automatically at the preset time, if tank's temperature is not reached to the desired temperature, then back-up heat device will be triggered, and when tank's temperature rises up to the desired value, then back-up heat device stops.

Factory set: (impossible to be adjusted)

- ◇ Default at 13:00 of the first time section to trigger the back-up heat device to heat tank to

- 30 °C,
- ✧ Default at 14:00 of the second time section to trigger the back-up heat device to heat tank to 35 °C,
- ✧ Default at 15:00 of the third time section to trigger the back-up heat device to heat tank to 40 °C,
- ✧ Default at 16:00 of the fourth time section to trigger the back-up heat device to heat tank to 45 °C,
- ✧ Default at 17:00 of the fifth time section to trigger the back-up heat device to heat tank to 50 °C.

i Note:

If larger power electrical heater (larger than 1500KW) is used, according to the power, we suggest configuring a contactor and a safety protection device, we suggest strongly installing an accessory “SR802” (see detailed in item No.12)



Main menu	Submenu	Factory set	Adjustable range	Step per adjust	Description
THET					Timing heating function
	THTS	S2	S2. S3		Select desired sensor of heated tank (S3 for T3, S2 for T2)
	SMT	OFF	ON/OFF		Intelligent heating Mode
	tH1O	04:00 / 40°C	00:00-23:59/ 0-93°C		Switch-on time and temperature of the first heating section
	tH1F	05:00/ 50°C	00:00-23:59/ 2-95°C		Switch-off time and temperature of the first heating section
	tH2O	10:00 / 40°C	00:00-23:59/ 0-93°C		Switch-on time and temperature of the second heating section

tH2F	10:00 / 50°C	00:00-23:59/ 2-95°C	Switch-off time and temperature of the second heating section
tH3O	17:00 / 50°C	00:00-23:59/ 0-93°C	Switch-on time and temperature of the third heating section
tH3F	22:00 / 55°C	00:00-23:59/ 2-95°C	Switch-off time and temperature of the third heating section

Function setting:

▶ Press “SET” button to access main menu, and select THET timing heating menu.

▶ Press “SET” button to set parameter, firstly to select the desired sensor for the heated tank, “THTS S2 displays on the screen.

▶ Press “SET” button, “S2 blinks

▶ Press “+/-” button to select desired sensor

▶ Press “SET” or “ESC” button to save the setting.

▶ Press “+” button to access submenu of the intelligent heating, “SMT OFF” displays on the screen

▶ Press “SET” button, “OFF” blinks

▶ Press “+/-” button to activate this function

▶ Press “SET” or “ESC” button to save the setting.

▶ Press “SET” button to access the window of the switch-on time and temperature of the first heating section, “th1O 04: 00” displays on the screen.

▶ Press “SET” button, hour time “04” blinks

▶ Press “+/-” button to adjust hour of the switch-on time

▶ Press “SET” button, minute time “00” blinks

▶ Press “+/-” button to adjust minute of the switch-on time

▶ Press “SET” button, temperature “40” blinks

▶ Press “+/-” button to adjust the switch-on temperature

▶ Press “SET” or “ESC” button to save the setting.

▶ Press “+” button to access the window of the switch-off time and temperature of the first heating section, “th1F 05: 00” displays on the screen

▶ Press “SET” button, hour time “05” blinks

▶ Press “+/-” button to adjust hour of the switch-off time

▶ Press “SET” button, minute time “00” blinks

▶ Press “+/-” button to adjust minute of the switch-off time



▶ Press “SET” button, temperature “50” blinks



- ▶ Press “+/-” button to adjust the switch-off temperature
- ▶ Press “SET” or “ESC” button to save the setting.
- ▶ Press “+” button to access the window of the switch-on time and temperature of the second heating section, repeat above steps to set time and temperature for the second and third heating section.



Note: definition of timing heating sign

- 1) Within the preset time section, if timing heating isn't working, heating sign  is lighted on the screen
- 2) Within the preset time section, if timing heating is working, heating sign  blinks on the screen.
- 3) Out of the preset time section, heating sign  doesn't display on the screen.

7.2 CIRC DHW circulation pump controlled by temperature and time

Function description:

This function is designed to get warm water quickly when customer opens the stopcock. In the case stopcock is closed, hot water pipe is also used as the circuit pipe. Two hot water circuit supply modes are available in this controller: temperature controlled mode and timing flow switcher controlled circuit mode. For using this function, an extra pump R2 and a flow switcher or a temperature sensor (mounted on the hot water return pipe (T4)) should be installed in the system.

Two control modes of CIRC pump:

- Within three time sections/ temperature controlled
- Within three time sections/ flow switcher controlled



Note:

1. for 2 DHW control modes, only one mode can be selected from three time - sections/temperature control mode and three time - sections /flow switcher control mode,
2. for 2 DHW control modes, three time - sections/temperature control mode and three time - sections /flow switcher control mode, their parameters adjust steps of two control mode are same.

- **Three time - sections / temperature control mode (tEP)**

Within the time - section (default: DHW temperature is less than 40oC, DHW circuit pump is trigger, when temperature rises to 45oC, DHW circuit pump is stopped).

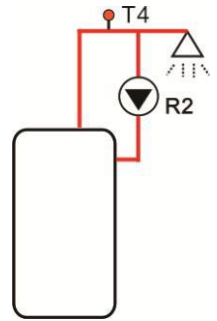

Trigger on conditions of temperature controlled DHW circuit pump (STAT): when tank temperature (upper temperature T3 is priority sensor) is 2°C higher than the preset switch-off temperature of this function (CYCF), DHW pump just can be triggered.

Default time - section set:

- The first time - section: starts at 05:00 and stops at 07:00 a.m.
- The second time - section: starts at 11:00 a.m. and stops at 13:00 p.m.
- The third time - section: starts at 17:00 and stops at 22:00 p.m.

i **Note:** if sensor T4 is installed, in order to avoid measuring error, please keep sensor's position to tank is 1.5m far.

● **Three time - sections / flow switcher control mode (FS)**

Function description:

Open the stopcock, water flows through pipe, a flow signal is felt by a flow switcher which is mounted on the cold-water pipe and sent to the controller, and then controller will trigger the DHW circuit pump (R2) and it pumps hot water from tank to the circuit pipe. The running time of circuit pump is adjustable, when the preset time runs out, pump stops.

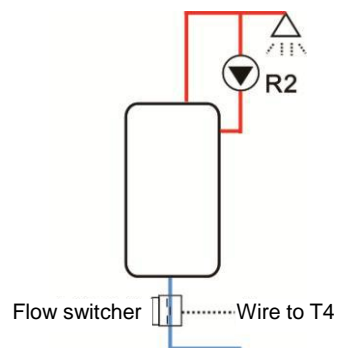

This stopcock seems like a remote controller to control the running of circuit pump. This operation mode is an environment-friendly, energy-saving control solution.

Open the stopcock for a shortly time, the flow switcher which is mounted on the cold flow pipe of tank will feel the flow signal, and then controller will trigger the circuit pump R2, and pump will feed hot water from tank to the pipe. Then when you re-open the stopcock, hot water flows out immediately. Once the pump's running time finishes, then pump is stopped. When hot water is not used, to avoid the heat releasing through pipe due to the running of circuit pump, controller will stop the pump after the pre-set running time. To avoid the pump

being re-triggered just after it stopped, parameter “rest time” is used for this control.

Open the stopcock within a pre-set time - section, pump running as the default design: pump running for every three minutes and then rest for 15minutes (the adjustable range of the running time is 1-30 MIN and the rest time is 0-60MIN)

i **Note:**

- A check valve should be installed before pump to avoid the water which is from tank being mixed with water from circuit pipe.
- If the stop time is set with value 0 minute, then when flow switcher feels the flow and thus to trigger the pump, pump will run for the whole time - section. And when the stopcock is closed, pump is stopped automatically.

Default time - section set:

- The first time - section: starts at 05:00 and stops at 07:00 a.m.
- The second time - section: starts at 11:00 and stops at 13:00
- The third time - section: starts at 17:00 and stops at 22:00 p.m.

● **Flow switch fitting:**

Material of fitting: brass

House: plastic

Connection: G3/4

Reed of flow switcher: Max 300V DC/1A

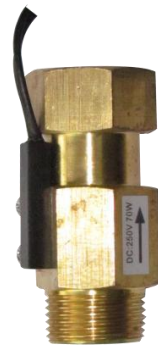

i **Note:**

- Noting the flow direction indicated on the flow switcher!
- No polarity of wires from flow switcher to the controller.
- Flow switcher is not included in the delivery list of this controller, please buy it separately.

Menu structure

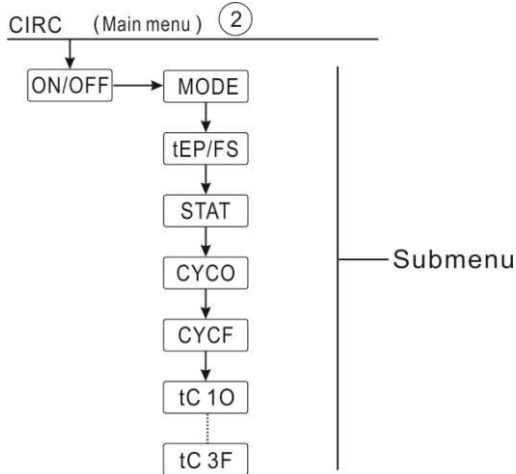

Main menu	Submenu 1	Submenu 2	Default set	Adjust range	Adjust step	Main menu
CIRC			OFF	ON/OFF		DHW circuit function
	MODE		FS	tEP/FS		Mode selection: tEP temperature control mode FS flow switcher control mode
		STAT	ON	ON/OFF		Trigger condition of DHW circuit pump Tank temperature (T3 priority) is 2°C higher than the switch-off temperature (CYFC) , only available in temperature control mode
		CYCO	40°C/3min	5-53°C/1-30min	0.5°C/1min	Switch-on temperature or running time
		CYCF	45°C/15min	7-55°C/0-60min	0.5°C/1min	Switch-off temperature or rest time
		t C1O	05:00	00:00-23:59		Start time of the first time-section
		t C1F	07:00	00:00-23:59		Close time of the first time-section
		t C2O	11:00	00:00-23:59		Start time of the second time-section
		t C2F	13:00	00:00-23:59		Close time of the second time-section
		t C3O	17:00 /	00:00-23:59 /		Start time of the third time-

					section
		t C3F	22:00	00:00-23:59	Close time of the third time - section

Function set: (take DHW three time - sections temperature control mode as example)

▶ Press “SET” button, select main menu CIRC



▶ Press “SET” button, “CIRC OFF” displays on the screen



▶ Press “SET” button, “OFF” blinks

▶ Press “+/-” button to activate the function, “CIRC ON” displays

▶ Press “SET” or “ESC” button, to confirm the setting

▶ Press “+”, “MODE FS” displays on the screen (three time - sections temperature control)

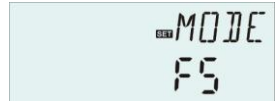

▶ Press “SET” button, “FS” blinks on the screen

▶ Press “+/-” button to select control mode, three-time sections/ temperature control mode.

▶ Press “SET” or “ESC” button, to confirm the setting

▶ Press “+”, “STAT ON” displays on the screen (trigger on conditions, this menu only available in the temperature control mode)



▶ Press “SET” button, “ON” blinks on the screen

▶ Press “+/-” button to deactivate this function

▶ Press “SET” or “ESC” button, to confirm the setting

▶ Press “+”, “CYCF 40°C” displays on the screen, to set the switch-on temperature of circuit pump function(if select flow switcher control mode, then here “CYCO 03Min” displays



▶ Press “SET” button, “40°C” blinks

▶ Press “+/-” to adjust the switch-on temperature of this function, adjust range is 0°C ~ (OFF-2°C)

▶ Press “SET” or “ESC” button, to confirm the setting

▶ Press “+”, “CYCF 45°C” displays on the screen, to set the switch-off temperature of circuit pump function



▶ Press “SET” button, “45°C” blinks

▶ Press “+/-” to adjust the switch-off temperature of this function, adjust range is (ON+2°C ~ 55°C)

- ▶ Press “SET” or “ESC” button, to confirm the setting
- ▶ Press “+”, “tC1O 05:00” displays on the screen, to set the start time of the first time section
- ▶ Press “SET” button, hour zone “05” blinks
- ▶ Press “+/-” to adjust the hour of start time of the first time section
- ▶ Press “SET” button, minute zone “00” blinks
- ▶ Press “+/-” to adjust the minute of the start time of the first time section
- ▶ Press “SET” or “ESC” button, to confirm the setting



- ▶ Press “+”, “tC1F 07:00” displays on the screen, to set the close time of the first time section
- ▶ Press “SET” button, hour zone “07” blinks
- ▶ Press “+/-” to adjust the hour of the close time of the first time section
- ▶ Press “SET” button, minute zone “00” blinks
- ▶ Press “+/-” to adjust the minute of the close time of the first time section
- ▶ Press “SET” or “ESC” button, to confirm the setting



▶ Press “+”, to enter the setting of the second time section, doing as above descript steps to set time of second and third time section.

If it is needed to close one time - section, then just set the start time and close time with a same time. (Example: at 10:00 start circuit, and at 10:00 close the circuit)

8. Function operation and parameter setup (engineer)

8.1 PWD Password



Access main menu, select “PWD 0000” to enter password

- ▶ Press “SET” button, the left digital blinks, enter password, factory set is “0000”
- ▶ Press “+/-”, to enter the first digital

- ▶ Press “SET”, the second digital blinks
- ▶ Press “+/-” to enter the second digital
- ▶ Press “SET”, the third digital blinks
- ▶ Press “+/-” to enter the third digital
- ▶ Press “SET”, the fourth digital blinks
- ▶ Press “+/-” to enter the fourth digital
- ▶ Press “SET”, to access main menu



Through password set to limit the user to change some parameters, 4 digitals needed. Default password is 0000

If no password is set, then just press “SET” five times to access main menu directly.

8.2 LOAD tank heating

Function description:

- **ΔT control logic**

The controller works as a standard temperature differential controller. If the temperature reaches or exceeds the switch-on temperature difference (DTO), the pump R1 switches on. When the temperature difference reaches or falls below the adjusted switch-off temperature difference (DTF), the respective relay R1 switches off.

i Note: The switch-on temperature difference must be 0.5K higher than the switch-off temperature difference. The set temperature difference must be at least 0.5K higher than the switch-on temperature difference.

- **Pump speed control**

If the temperature reaches or exceeds the set point of the switch-on temperature difference, pump is triggered and runs for 10 seconds at the 100% speed, and then, pump speed is reduced to its lowest pump speed.

If the temperature reaches the set temperature difference TDS, pump speed is increased 10%, controller will adjust by parameter RIS to meet this change. Temperature difference rises a range which defined by parameter RIS, pump speed increases 10% until to its maximum pump speed 100%. If temperature difference drops a range which defined by parameter RIS, pump speed reduces 10% accordingly.

i Note: in order to activate the pump speed control function, control type of the

corresponding of pump should be set (MIN, MAX), there are 4 pump control types, they are PULS, PSOL, PHEA or 0-10V (adjustable under menu pump)

● **SMX Maximum tank temperature protection set**





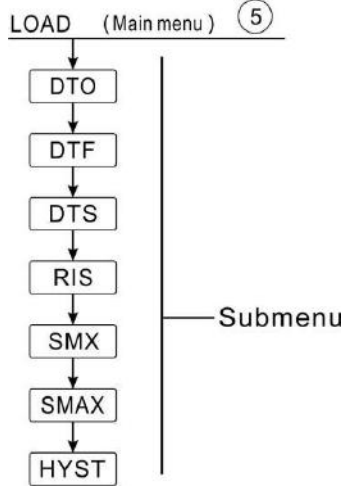

If the tank temperature reaches the adjusted maximum temperature, then tank will no longer be loaded in order to avoid damage caused by overheating. If the maximum tank temperature is exceeded, sign  is displayed on the screen.

The sensor for tank maximum limitation (SMAX) can be selected. The maximum limitation always refers to the sensor selected (T2 or T3). The switch-on hysteresis (HYST) is selectable (Default is 2°C), for example, when tank maximum temperature is set to 70°C, then at 68°C, Maximum tank temperature protection function is deactivated automatically.

Menu Structure					
LOAD (Main menu) ⑤					
					
Main menu	Submenu	Factor y set	Adjustabl e range	Step per adjust	Description
LOAD					Tank heating
	DTO	6K	1-50K	0.5K	Switch-on temperature difference of tank heating
	DTF	4K	0.5-49.5K	0.5K	Switch-off temperature difference of tank heating
	DTS	10K	1.5-50K	0.5K	Temperature difference of pump speed adjust
	RIS	2K	1-20K	1K	Temperature increase range for pump

					speed adjust
	SMX	70°C	4-95°C	1°C	Maximum temperature of tank
	SMAX	S2	S2, S3		Sensor for Maximum temperature of tank (S3 for T3, S2 for T2)
	HYST	2K	0.1-10K	0.1K	Hysteresis of maximum temperature of tank

Setup the function

- ▶ Select “LOAD” main menu 
- ▶ Press “SET”, “DTO 6K” displays on the screen 
- ▶ Press “SET”, “6K” blinks
- ▶ Press “+/-”, to adjust the switch-on temperature of the solar circuit pump
- ▶ Press “SET” or “ESC” to save the setting
- ▶ Press “+”, “DTF 4K” displays on the screen 
- ▶ Press “SET”, “4K” blinks
- ▶ Press “+/-”, to adjust the switch-off temperature of solar circuit pump
- ▶ Press “SET” or “ESC” to save the setting
- ▶ Press “+”, “DTS 10K” displays on the screen 
- ▶ Press “SET”, “10K” blinks
- ▶ Press “+/-”, to adjust the standard temperature difference of pump speed control function
- ▶ Press “SET” or “ESC” to save the setting
- ▶ Press “+”, “RIS 2K” displays on the screen 
- ▶ Press “SET”, “2K” blinks
- ▶ Press “+/-”, to adjust the increase range of temperature difference of pump speed control function
- ▶ Press “SET” or “ESC” to save the setting
- ▶ Press “+”, “SMX 70°C” displays on the screen 
- ▶ Press “SET”, “70°C” blinks
- ▶ Press “+/-”, to adjust the maximum temperature of tank
- ▶ Press “SET” or “ESC” to save the setting
- ▶ Press “+”, “SMAX S2” displays on the screen 
- ▶ Press “SET”, “S2” blinks
- ▶ Press “+/-”, select the sensor for maximum temperature of tank (S3 for T3, S2 for T2)



- ▶ Press “SET” or “ESC” to save the setting
- ▶ Press “+”, “HYST 2K” displays on the screen
- ▶ Press “SET”, “2K” blinks
- ▶ Press “+/-”, to adjust the hysteresis of tank maximum temperature
- ▶ Press “SET” or “ESC” to save the setting



8.3 COL Collector function

Function description

- **OCEM Collector emergency shutdown**

When the collector temperature exceeds the adjusted collector emergency temperature, Then solar pump (R1) switches off in order to protect the system components against overheating (collector emergency shutdown). If the maximum collector temperature (OCEM) is exceeded, sign   blinks on the screen.

 **Warning!** Risk of injury! Risk of system damage by pressure surge! If water is used as the heat transfer fluid in pressure systems, water will boil at 100 °C. Then do not set the collector limit temperature higher than 95 °C.

- **OCCO Collector cooling**

The collector cooling function keeps the collector temperature rising within the operating range by heating the tank. If the tank temperature reaches 95°C the function will be switched off for safety reason.

When the tank temperature exceeds the adjusted maximum temperature of tank, then solar system is switched off. If the collector temperature rises up to its adjusted maximum collector temperature, the solar pump is switched on again until the collector temperature falls below the maximum collector temperature. The tank temperature may then exceed its maximum temperature, but only up to 95°C (emergency shutdown of the tank), and sign  blinks on the screen, system stops.

If the collector cooling is active,  blinks on the screen.

 **Note:** This function is only available when the heat transfer function (OHDP) is not activated.

- **OCMI Collector minimum temperature**

The minimum collector temperature is the lowest temperature of collector, only when collector temperature is higher than that temperature, solar pump (R1) just can be switched-on, if the collector temperature falls below the adjusted minimum temperature,

Sign  blinks on the screen (slowly blinks).

- **OCFR Collector antifreeze function**

Collector antifreeze function activates the loading circuit between the collector and the tank when the collector temperature falls below the adjusted temperature **CFRO**. This will protect the fluid against freezing or coagulating. If collector temperature exceeds the switch-off temperature of collector antifreeze function CFRF, the solar pump will be switched off again.

If collector antifreeze function is activated, sign  blinks on the screen.



Note: Since this function uses the limited heat which is saved in the tank, so the antifreeze function should be used only in regions where the ambient temperature is around the freezing point only for a few days.

- **OTCO Tube collector function**

This function is designed for the system in which the position of collector sensor is not ideal; purpose is to improve the system efficiency (for example for system use tube collector), this function runs just within a set time section, controller will intermittent trigger solar pump (R1) to push the hot water from tube collector to the position of sensor, to avoid the delay measuring temperature.

If the running time is set over 10 seconds, then within the first 10seconds, pump runs at 100% speed, and at the remain time, pump runs at its lowest pump speed.

If the sensor of collector is damaged, then this function is deactivated automatically.

Menu structure

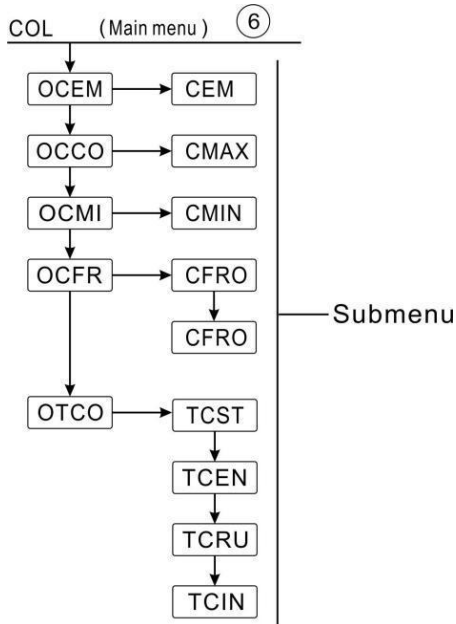

Main menu	Submenu 1	Submenu 2	Factory set	Adjustable range	Step per adjust	Description
COL						Collector function
	OCEM		ON			Collector emergency shutdown function on/ff
		CEM	130°C	80-200°C	1°C	Temperature of collector emergency shutdown(hysteresis 10K)
	OCCO		OFF			Collector cooling function on/off
		CMAX	110°C	70-160°C	1°C	Temperature of collector cooling (hysteresis 5°C)
	OCMI		OFF			Collector minimum temperature function on/off
		CMIN	10°C	10-90°C	1°C	Temperature of collector minimum function
	OCFR		OFF			Anti-freeze function on/off
		CFRO	4°C	-40-8°C	0.5°C	Switch-on temperature of

						anti-freeze function
		CFRF	5°C	-39-9°C	0.5°C	Switch-off temperature of anti-freeze function
	OTCO					Tube collector function
		TCST	07:00	00:00-23:00	1min	Start time of tube collector function
		TCEN	19:00	00:00-23:00	1min	Stop time of tube collector function
		TCRU	30s	30-300s	1s	Running time of tube collector function
		TCIN	30min	5-60min	1min	Interval time of tube collector function

Function setting:

OCEM (Collector emergency shutdown function) setup

- ▶ Select “COL” function menu
 - ▶ Press “SET”, “OCEM” displays on the screen
 - ▶ Press “SET” again, “OCEM ON” displays on the screen
 - ▶ Press “SET”, “ON” blinks on the screen
- (If it is necessary to shut down this function, press “+/-” to deactivate it)
- ▶ Press “SET” or “ESC” to save the setting
 - ▶ Press “+”, “OCEM 130°C” displays on the screen
 - ▶ Press “SET”, “130°C” blinks on the screen
 - ▶ Press “+/-”, to adjust the temperature of the collector emergency function
 - ▶ Press “SET” or “ESC” to save the setting
 - ▶ Press “ESC” to return to previous menu



OCCO (Collector cooling function) setup

- ▶ Select OCCO submenu, “OCCO” displays on the screen
- ▶ Press “SET”, “OCEM OFF” displays on the screen
- ▶ Press “SET”, “OFF” blinks on the screen
- ▶ Press “+/-”, to activated this function, “OCEM ON” displays on



the screen

- ▶ Press “+”, “CMAX 110°C” displays on the screen
- ▶ Press “+/-”, to adjust the switch-on temperature of collector cooling function
- ▶ Press “SET” or “ESC” to save the setting
- ▶ Press “ESC” to return to previous menu



OCMI (Collector minimum temperature) setup

- ▶ Select OCMI submenu, “OCMI” displays on the screen
- ▶ Press “SET”, “OCMI OFF” displays on the screen
- ▶ Press “SET”, “OFF” blinks on the screen
- ▶ Press “+/-”, to activate this function, “OCMI ON” displays on the screen
- ▶ Press “+”, “OCMI 10°C” displays on the screen
- ▶ Press “+/-”, to adjust the minimum temperature of collector
- ▶ Press “SET” or “ESC” to save the setting
- ▶ Press “ESC” to return to previous menu



OCFR (Antifreeze function) setup

- ▶ Select OCFR submenu, “OCFR” displays on the screen
- ▶ Press “SET”, “OCFR OFF” displays on the screen
- ▶ Press “SET”, “OFF” blinks on the screen
- ▶ Press “+/-”, to activate this function, “OCFR ON” displays on the screen
- ▶ Press “+”, “CFRO 4°C” displays on the screen
- ▶ Press “SET”, “4°C” blinks on the screen
- ▶ Press “+/-”, to adjust the switch-on temperature of antifreeze function
- ▶ Press “SET” or “ESC” to save the setting
- ▶ Press “+”, “CFRF 5°C” displays on the screen
- ▶ Press “SET”, “5°C” blinks on the screen
- ▶ Press “+/-”, to adjust the switch-off temperature of antifreeze function
- ▶ Press “SET” or “ESC” to save the setting
- ▶ Press “ESC” to return to previous menu



OTCO (Tube collector function) setup

- ▶ Select OTCO submenu, “OTCO” displays on the screen
- ▶ Press “SET”, “OTCO OFF” displays on the screen
- ▶ Press “SET”, “OFF” blinks on the screen
- ▶ Press “+/-”, to activate this function, “OTOC ON” displays on the screen
- ▶ Press “+”, “TCST 07:00” displays on the screen
- ▶ Press “SET”, “07” blinks on the screen
- ▶ Press “+/-”, to adjust hour time
- ▶ Press “SET”, “00” blinks on the screen
- ▶ Press “+/-”, to adjust minute time
- ▶ Press “SET” or “ESC” to save the setting
- ▶ Press “+”, “TCEN 19:00” displays on the screen
- ▶ Press “SET”, “19” blinks on the screen
- ▶ Press “+/-”, to adjust hour time
- ▶ Press “SET”, “00” blinks on the screen
- ▶ Press “+/-”, to adjust minute time
- ▶ Press “SET” or “ESC” to save the setting
- ▶ Press “+”, “TCRU 30” displays on the screen
- ▶ Press “SET”, “30” blinks on the screen
- ▶ Press “+/-”, to adjust running time
- ▶ Press “SET” or “ESC” to save the setting
- ▶ Press “+”, “TCIN 30Min” displays on the screen
- ▶ Press “SET”, “30” blinks on the screen
- ▶ Press “+/-”, to adjust stop time
- ▶ Press “SET” or “ESC” to save the setting
- ▶ Press “ESC” to return to previous menu



8.4 PUMP Pump control mode

Function description:

Through this function, pump control mode can be adjusted, below modes can be selected:

For standard pump adjust without pump speed control

- Adjustment for standard pump without speed control:
ONOF: Pump on / pump off

- Adjustment for standard pump with speed control:
PULS: Burst control via semiconductor relay
- Adjustment for high-efficiency pump (HE pump)

• PSOL: PWM profile solar pump

PWM signal logic (solar):

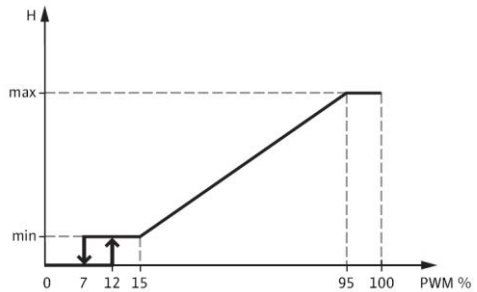

• PHEA: PWM profile heating pump

PWM signal logic (heating):

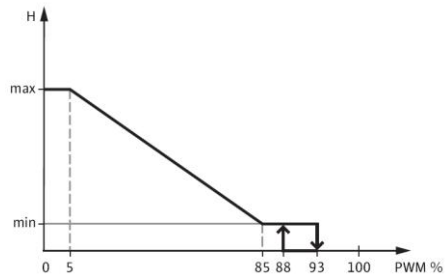

• 0-10: Speed control via 0 - 10 V signal

PWM(0-10V) signal logic

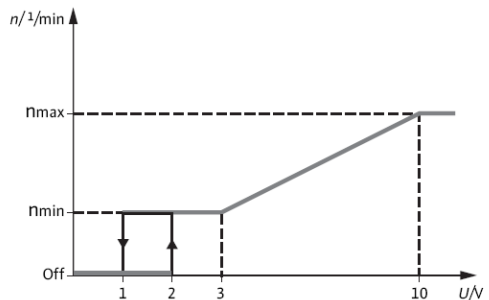

i Note:

1. More information about connection of high efficiency pump see the paragraph (3.5 Connection with high efficiency pump)
2. Minimum pump speed: under menu MIN1, the corresponding minimum pump speed is allocated to output R1.
3. Maximum pump speed: under menu MAX1, the corresponding maximum pump speed is

allocated to output R1.

4. When a output is used to control a device without pump speed control (e.g. to control a motored valve), then the pump speed of the corresponding relay should be set with a value of 100% or set the control type is ONOF to deactivate the pump speed control function.

Menu Structure:

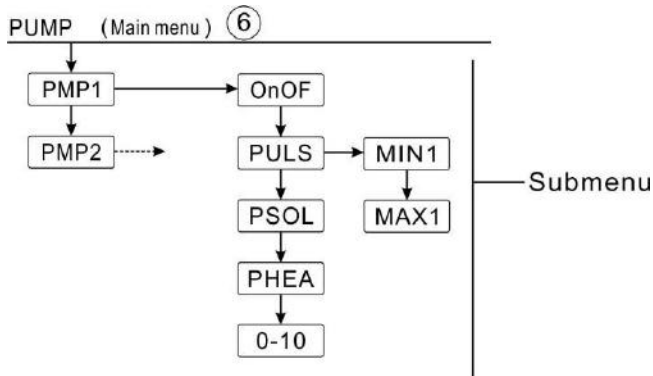

Main menu	Submenu 1	Submenu 2	Factor y set	Adjustable range	Step per adjust	Description
PUMP						Pump control mode
	ONOF		ON	ON/OFF		Pump on/off (standard pump control mode without pump speed control)
	PULS		OFF	ON/OFF		Pulse control of standard pump (through semiconductor relay to trigger pump)
		MIN1	50%	20-95%	5%	
		MAX1	100%	25-100 %	5%	
	PSOL		OFF	ON/OFF		PWM solar pump control
		MIN1	50%	20-95%	5%	
		MAX1	100%	25-100 %	5%	
	PHEA		OFF	ON/OFF		PWM heating pump control
		MIN1	50%	20-95%	5%	
		MAX1	100%	25-100 %	5%	
	0-10		OFF	ON/OFF		0-10V signal control pump speed
		MIN1	50%	20-95%	5%	
		MAX1	100%	25-100 %	5%	

Setup function:

- ▶ Select PUMP submenu,
- ▶ Press “SET”, “ONOF ON” displays on the screen
- ▶ Press “+/-”, to select pump type “PULS, PSOL, PHEA, 0-10V
- ▶ After select the pump type, press “SET” to enter the pump type
- ▶ Press “SET”, “OFF” blinks on the screen
- ▶ Press “+/-”, to activate it
- ▶ Press “SET” or “ESC” to save the setting
- ▶ Press “ESC” to return to previous menu

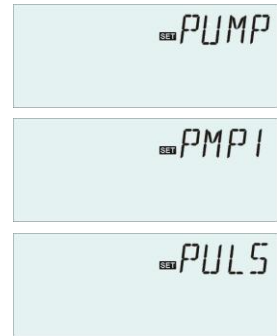

i **Note:**

Only one pump type can be selected from “ONOF、PLUS、PSOL、PHEA、0-10V” five pump types

For example: select “PLUS ON”, then other four options is closed automatically.

8.5 COOL Cooling function

Function description

3 cooling functions for different devices can be activated by this function: system cooling, tank cooling and heat transferring by external radiator

- **OSYC System cooling**

Purpose of system cooling is to last the lifetime of a solar system, this function will override the limitation of tank maximum temperature and enable collector to transfer the heat produced by collector to tank continuously. If tank temperature reaches its maximum temperature already and the switch-on temperature difference DT_{CO} is reached also, then solar system will remain running and heating the tank until the switch-off temperature difference DT_{CF} or the collector emergency temperature OCEM reaches.

i **Note:** this function is only enabled in the case that collector cooling function and heat transferring function are closed.

- **OSTC Tank cooling**

When the tank cooling function is activated, the controller aims to cool down the tank during the night in order to prepare it for solar loading on the following day. If the tank temperature exceeds the adjusted maximum tank temperature SMAX, the collector temperature falls below the tank temperature and downwards to the switch-on temperature difference DT_{CO}

of this cooling function, then system will be activated in order to cool down the tank by releasing the energy through the collector.

If tank cooling function is activated, sign ☀️ blinks on the screen

i **Note:** if tank temperature reaches to 95 °C, all cooling functions will be locked.

Hysteresis switch on temperature difference is 5K.

● **OHDP Heat transferring by external radiator**

Heat transferring by external radiator function is designed to transfer the excess heat which is generated under the strong solar irradiation through an external heat exchanger (e. g. fan coil); the purpose is to keep the collector's or tank's temperature within the operating range.

For this function, an extra output should be added (R2 or R3 as option)

Heat transferring by external radiator function can control either an additional pump or a valve (**OTPM ON** = pump logic, **OTPM OFF** = valve logic).

Pump logic controlled thermal transferring function:

If the temperature (T1) of collector reaches the set point of switch-on temperature, pump (R2/R3) will be triggered. If the temperature (T1) of collector drops below 5K to the over-heat temperature, pump (R2/R3) will be ceased.

Valve logic controlled thermal transferring function:

If the temperature (T1) of collector reaches the set point of the switch-on temperature, temperature difference circuit pump (R1) and valve (R2/R3) will be triggered simultaneously. If the temperature (T1) of collector drops below 5K to the over-heat temperature, pump (R1) and valve (R2/R3) will be ceased simultaneously.

Below is the example of this application for reference.

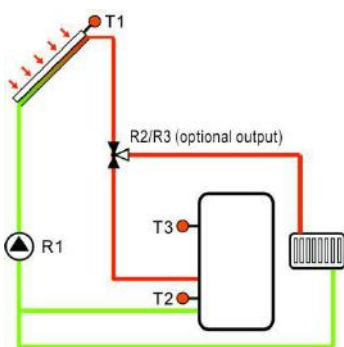

Collector valve logic heat transferring

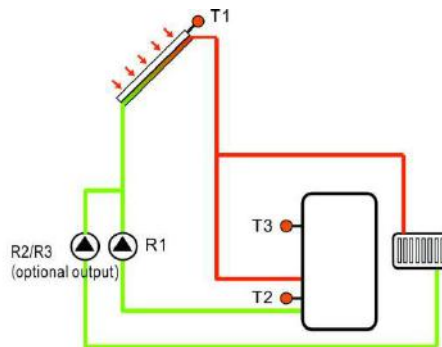

Collector pump logic heat transferring

Sign  displays on the screen, it indicates that valve logic heat transferring is running.

Sign  displays on the screen, it indicates that pump logic heat transferring is running.

i Note:

1. When collector overheat temperature OTST is 10K below the CEM temperature of collector emergency shutdown, then collector overheat temperature OTST is locked.
2. Heat transferring function is only available when collector cooling function (OCCO) is deactivated.

Menu structure

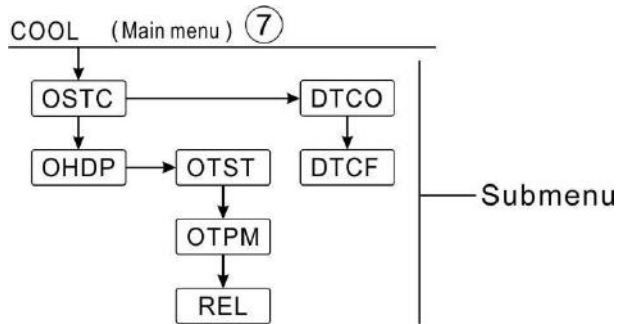

Main menu	Submenu 1	Submenu 2	Factory set	Adjustable range	Step per adjust	Description
COOL						Cooling function
	OSYC		OFF	ON/OFF		System cooling function
	OSTC		OFF	ON/OFF		Tank cooling function
		DTCO	20K	1-30K	0.5K	Switch-on temperature difference of cooling function
		DTCF	15K	0.5-29.5K	0.5K	Switch-off temperature difference of cooling function
	OHDP		OFF	ON/OFF		Heat transferring by external radiator (only in case there is available output)
		OTST	80°C	20-160°C	1°C	Temperature set point for heat transferring (hysteresis 5°C)
		OTPM	ON	OTPM ON=pump logic OTPM OFF=valve logic		Pump control logic and valve control logic
		REL	R2	R3,R2		Output ports

Function setting:

OSYC (System cooling) setup

- ▶ Press “SET”, “OSYC OFF” displays on the screen
- ▶ Press “SET”, “OFF” blinks on the screen
- ▶ Press “+/-”, to activate this function
- ▶ Press “ESC” to return to previous menu



OSTC (Tank cooling) setup

- ▶ Select “OSTC” function submenu, "OSTC" displays on the screen
- ▶ Press “SET”, “OSTC OFF” displays on the screen
- ▶ Press “SET”, “OFF” blinks on the screen
- ▶ Press “+/-”, to activate this function
- ▶ Press “+”, “DTCO 20K” displays on the screen
- ▶ Press “SET”, “20K” blinks on the screen
- ▶ Press “+/-”, to adjust the switch-on temperature difference of tank cooling function
- ▶ Press “SET” or “ESC” to save the setting
- ▶ Press “+”, “DTCF 15K” displays on the screen
- ▶ Press “SET”, “15K” blinks on the screen
- ▶ Press “+/-”, to adjust the switch-off temperature difference of tank cooling function
- ▶ Press “SET” or “ESC” to save the setting
- ▶ Press “ESC” to return to previous menu



OHDP (Heat transferring) setup

- ▶ Select “OHDP” function sub-menu, "OHDP" displays on the screen
- ▶ Press “SET”, “OHDP OFF” displays on the screen
- ▶ Press “SET”, “OFF” blinks on the screen
- ▶ Press “+/-”, to activate this function, “OHDP ON” displays on the screen
- ▶ Press “+”, “OTST 80°C” displays on the screen
- ▶ Press “SET”, “80°C” blinks on the screen
- ▶ Press “+/-”, to adjust the switch-on temperature of heat transferring function



- ▶ Press “SET” or “ESC” to save the setting
- ▶ Press “+”, “OTPM ON” displays on the screen
- ▶ Press “SET”, “ON” blinks on the screen
- ▶ Press “+/-”, to select pump logic or valve logic for heat transferring function
- ▶ Press “SET” or “ESC” to save the setting
- ▶ Press “+”, “REL 2” displays on the screen
- ▶ Press “SET”, “2” blinks on the screen
- ▶ Press “+/-”, to select the output port for heat transferring function
- ▶ Press “SET” or “ESC” to save the setting
- ▶ Press “ESC” to return to previous menu



8.6 AUX Auxiliary function

Function description:

- **TIME Timer function**

Timer function can trigger controller’s output port at the preset time; therefore, an available output (R3) is needed.

- **AH Thermostat function**

The thermostat function works independently from the solar operation and can be used for using surplus energy to reduce tank temperature or for using after heating to rise tank temperature. (Every day 3 heating time sections can be set).



Note:

- **AHO < AHF:** Thermostat function is used for after heating
- **AHO > AHF:** Thermostat function is used for releasing surplus energy from tank.
 - ◇ When sign **AH** displays on the screen, it indicates that thermostat function is activated.
 - ◇ When sign **AH** blinks on the screen (blinks quickly) , it indicates that thermostat function (heating) is running.
 - ◇ When sign **AH** blinks on the screen (blinks slowly) , it indicates that thermostat function (heat releasing) is running.

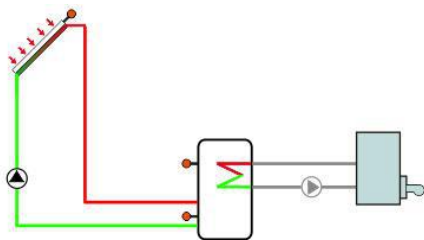

After heating

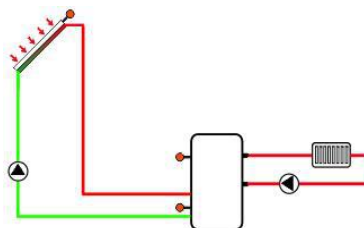

Releasing heating

BEEP Beeper fault warning

When system has fault (temperature sensor fault, no flow etc), beeper sends out warning

Menu Structure

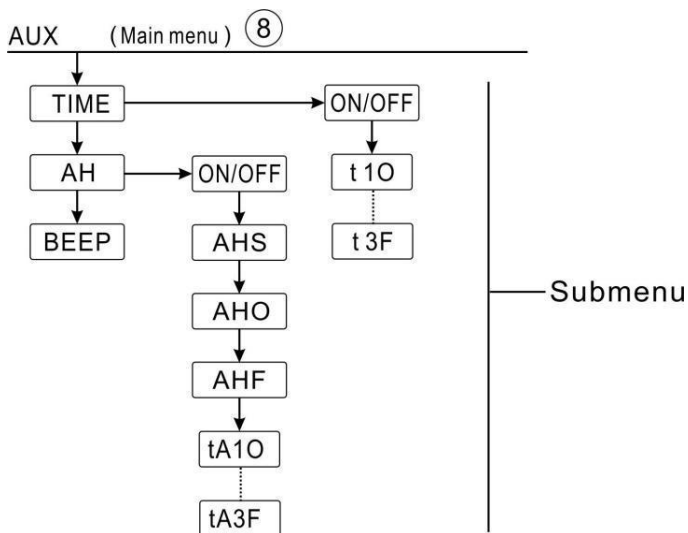

Main menu	Sub menu 1	Sub menu 2	Factor y set	Adjustable range	Step per adjust	Description
AUX						Auxiliary functions
	TIME		OFF	ON/OFF		Timer function
		t 10	00:00	00:00-23:59		Start time of the first time section
		t 1F	00:00	00:00-23:59		Close time of the first time section
		t 20	00:00	00:00-23:59		Start time of the second time section
		t 2F	00:00	00:00-23:59		Close time of the second time section

		t 3O	00:00	00:00-23:59		Start time of the third time section
		t 3F	00:00	00:00-23:59		Close time of the third time section
	AH		OFF	ON/OFF		Thermostat function
		AHS	S3	S2/S3/S5		Allocated sensor for thermostat function (S3 for T3, S2 for T2, S5 for T5)
		AHO	40℃	0.0-95℃	0.5℃	Switch-on temperature
		AHF	45℃	0.0-94.5℃	0.5℃	Switch-off temperature
		t A1O	00:00	00:00-23:59		Start time of the first time section
		t A1F	23:59	00:00-23:59		Close time of the first time section
		t A2O	00:00	00:00-23:59		Start time of the second time section
		t A2F	00:00	00:00-23:59		Close time of the second time section
		t A3O	00:00	00:00-23:59		Start time of the third time section
		t A3F	00:00	00:00-23:59		Close time of the third time section
	BEEP		OFF	ON/OFF		Beeper warning function (sensor fault, no flow)

Function Setting

● TIME (Timer function) Setting

▶ Select AUX main menu, press “SET”, to access TIME submenu



▶ Press “SET”, “TIME OFF” displays on the screen



▶ Press “SET”, “OFF” blinks

▶ Press “+/-”, to activate this function, “TIME ON” displays

▶ Press “SET” or “ESC” to save the setting

▶ Press “+”, “t1O 00:00” displays on the screen



▶ Press “SET”, hour “00” blinks

▶ Press “+/-”, to adjust hour of the start time of the first section

▶ Press “SET”, minute “00” blinks

▶ Press “+/-”, to adjust minute of the start time of the first section

▶ Press “SET” or “ESC” to save the setting



▶ Press “+”, “t1F 00:00” displays on the screen

▶ Press “SET”, hour “00” blinks

▶ Press “+/-”, to adjust the hour of the close time of the first time section

- ▶ Press “SET”, minute “00” blinks
- ▶ Press “+/-” to adjust the minute of the close time of the first time section
- ▶ Press “SET” or “ESC” to save the setting
- ▶ Press “+”, access the setting of the second time section, repeat above steps to set time of second and third sections.

If you want to close the timer for one section, just set a same time for the start and close time (e.g. 10:00 start, 10:00 close)

● **AH (Thermostats function) setting**

- ▶ Select AH submenu, “AH” displays on the screen
- ▶ Press “SET”, “AH OFF” displays
- ▶ Press “SET”, “OFF” blinks
- ▶ Press “+/-”, to activate this function, “AH ON” displays on the screen
- ▶ Press “SET” or “ESC” to save the setting



- ▶ Press “+”, “AHS S3” displays on the screen
- ▶ Press “SET”, “S3” blinks
- ▶ Press “+/-”, to select the object sensor for thermostat function
- ▶ Press “SET” or “ESC” to save the setting



- ▶ Press “+”, “AHO 40°C” displays
- ▶ Press “SET”, “40°C” blinks
- ▶ Press “+/-”, to adjust the switch-on temperature
- ▶ Press “SET” or “ESC” to save the setting



- ▶ Press “+”, “AHF 45°C” displays
- ▶ Press “SET”, “45°C” blinks
- ▶ Press “+/-”, to adjust the switch-off temperature of thermostat function
- ▶ Press “SET” or “ESC” to save the setting

- ▶ Press “+”, “tA1O 00:00” displays
- ▶ Press “SET”, hour “00” blinks
- ▶ Press “+/-”, to adjust the hour of start time of the first time section
- ▶ Press “SET”, minute “00” blinks
- ▶ Press “+/-”, to adjust the minute of start time of the first time section



- ▶ Press “SET” or “ESC” to save the setting



- ▶ Press “+”, “tA1F 23:59” displays on the screen
- ▶ Press “SET”, “23” blinks
- ▶ Press “+/-”, to adjust the hour of close time of the first time section
- ▶ Press “SET”, “59” blinks
- ▶ Press “+/-”, to adjust the minute of close time of the first time section
- ▶ Press “SET” or “ESC” to save the setting
- ▶ Press “+”, access the setting of the second time section, repeat above steps to set time of second and third sections.

If you want to close the thermostat function for one section, just set a same time for the start and close time (e.g. 10:00 start, 10:00 close)

● **BEEP (Beeper warning function) setting**

- ▶ Select BEEP submenu, “BEEP” displays on the screen
- ▶ Press “SET”, “BEEP OFF” displays on the screen
- ▶ Press “SET”, “OFF” blinks
- ▶ Press “+/-”, to activate this function, “BEEP ON” displays on the screen
- ▶ Press “SET” or “ESC” to save the setting



8.7 MAN Manual operation

For control and service work, the operating mode of the relays can be manually adjusted. For this purpose, select the adjustment menu MAN (for R1, R2, R3, HR) to set output “On/OFF” Manually.

Note: When manual mode is activated, sign (👆) blinks on the screen, controller runs for 15 minutes and then switch-off all outputs, control exits manual mode automatically.

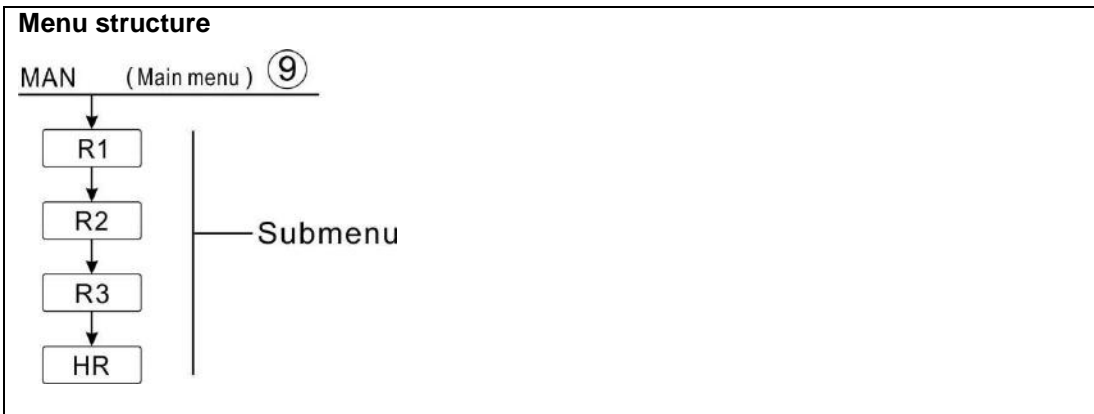

Main Menu	Submenu	Factory set	Adjustable range	Description
MAN				Manual mode
	R1	OFF	ON/OFF	R1 on and off
	R2	OFF	ON/OFF	R2 on and off
	R3	OFF	ON/OFF	R3 on and off
	HR	OFF	ON/OFF	HR on and off

Function setup

- ▶ Select “MAN” main menu.
- ▶ Press “SET”, “R1 OFF” displays
- ▶ Press “SET”, “OFF” blinks
- ▶ Press “+/-”, to activate this function, “R1 ON” displays
- ▶ Press “SET” or “ESC” to save the setting
- ▶ Press “+”, “R2” displays, repeat above steps to set the manual output of R2, R3, HR.



i Note: when an output is triggered manually, only this output is triggered, others running output will be stopped.

8.8 BLPR Blocking protection

Function description:

In order to protect the pumps against blocking after standstill, the controller is equipped with a blocking protection function. This function switches on the relays one after another every day at 12:00 am and let them run for 10s.



Function setting

- ▶ Select BLPR main menu,
- ▶ Press “SET”, “BLPR OFF” displays
- ▶ Press “SET”, “OFF” blinks



- ▶ Press “+/-”, to activate this function, “BLPR ON” displays on the screen
- ▶ Press “SET” or “ESC” to save the setting



8.9 OTDI Thermal Sterilization Function

Function description:

This function helps to prevent the spread of Legionella in DHW tanks by systematically activating the after-heating.

For thermal disinfection, the temperature at the allocated sensor has to be monitored. During the monitoring period PDIS, this protection ensures the disinfection temperature is continuously exceeded the disinfection temperature TDIS for the entire disinfection period DDIS. Thermal disinfection can only be completed when the disinfection temperature is exceeded for the duration of the disinfection period without any interruption.

The monitoring period PDIS starts as soon as the temperature at the allocated sensor falls below the disinfection temperature TDIS, once the monitoring period PDIS ends, disinfection period SDIS starts, and the allocated reference relay activates the after-heating, when tank temperature exceeds the disinfection temperature, disinfection phase DDIS starts and disinfection heating time countdowns, countdown finishes, disinfection heating finishes.

Menu Structure					
OTDI (Main menu) ⑪ ↓ PDIS ↓ DDIS ↓ TDIS ↓ SDIS — Submenu					
Menu	Submenu	Factor y set	Adjustable range	Step per adjust	Description
OTDI		OFF	ON/OFF		Disinfection function
	PDIS	7d	0-30d	1d	Time section of disinfection monitoring
	DDIS	10min	1-180	1min	Heating time of disinfection
	TDIS	70°C	0-90°C	1°C	Temperature of disinfection
	SDIS	18:00	00:00-21:00	1:00	Start time of disinfection

Function setting

- ▶ Select OTDI main menu
- ▶ Press “SET”, “OTDI OFF” display
- ▶ Press “SET”, “OFF” blinks
- ▶ Press “+/-”, to activate this function, “OTDI ON” displays
- ▶ Press “SET” or “ESC” to save the setting
- ▶ Press “+”, “PDIS 7” displays
- ▶ Press “SET”, “7” blinks
- ▶ Press “+/-”, to adjust the days for disinfection monitoring,
- ▶ Press “SET” or “ESC” to save the setting
- ▶ Press “+”, “DDIS 10Min” displays on the screen
- ▶ Press “SET”, “10” blinks
- ▶ Press “+/-”, to adjust the heating time of disinfection
- ▶ Press “SET” or “ESC” to save the setting
- ▶ Press “+”, “TDIS 70°C” displays on the screen
- ▶ Press “SET”, “70°C” blinks
- ▶ Press “+/-”, to adjust the temperature of disinfection
- ▶ Press “SET” or “ESC” to save the setting
- ▶ Press “+”, “SDIS 18:00” displays on the screen
- ▶ Press “SET”, “18” blinks
- ▶ Press “+/-”, to adjust the start time of the disinfection
- ▶ Press “SET” or “ESC” to save the setting



8.10 OPAR Parallel relays

Function Description:

Controller enables a separated relay (R3) and pump relay (R1) to parallel control a motored valve or a pump.

If solar system runs (R1) or if solar function is activated, then the corresponding allocated parallel relay R3 is also energized. Parallel relays can be off reversely.

INVE OFF, then R1 is energized, parallel relay R3 is energized also.

INVE ON, then R1 is de-energized, but parallel relay R3 is energized

Menu Structure:

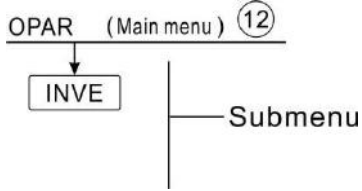

Menu	Submenu	Factory set	Adjustable range	Step per adjust	Description
OPAR		OFF	ON/OFF		Parallel relays on/off
	INVE	OFF	ON/OFF		Logic of parallel relays on/off

Function setting

- ▶ Select OPAR main menu
- ▶ Press “SET”, “OPAR OFF” display
- ▶ Press “SET”, “OFF” blinks
- ▶ Press “+/-”, to activate this function, “OPAR ON” displays
- ▶ Press “SET” or “ESC” to save the setting
- ▶ Press “+”, “INVE OFF” displays
- ▶ Press “SET”, “OFF” blinks
- ▶ Press “+/-”, to activate this function, “INVE ON” appears on the screen
- ▶ Press “SET” or “ESC” to save the setting



8.11 OHQM Thermal energy measuring

Three thermal energy measuring methods are designed in this controller, you can select one to measure the thermal energy produced by the solar system.

- 1: Fixed value of flow (glass tube flow meter)
- 2: Grundfos flow sensor VFS
- 3: Rotated flow meter FRT

- **Thermal energy measuring with fixed value of flow (estimated measuring)**

Controller calculates thermal energy used parameters value from sensor T6 on flow pipe, sensor T5 on the return pipe and enters a flow rate which get from fixed flow meter at pump speed of 100%.

i **Note:** sensors on the flow and return pipe for thermal energy measuring are defaulted, not available for set.

- Under FTYP menu to set flow meter type 1
- Read flow rate (L/min) from flow meter and enter this value under menu FMAX.
- Under menu MEDT and MED% to set the anti-frozen type and concentration of fluid medium

Anti-frozen type (MEDT):

0: Water

1: Propylene glycol

2: Glycol

3: Tyfocol LS/G-LS

● **Thermal energy measuring with Grundfos flow sensor VFS**

Controller calculates thermal energy used parameters value from sensor T6 on flow pipe, sensor T5 on the return pipe and flow rate which send to controller from Grundfos flow sensor VFS.

TVFS: temperature of Grundfos flow sensor VFS

i **Note:**

1. Sensors on the flow and return pipe for thermal energy measuring are defaulted, not available for set.
2. Flow detecting function is available only when VFS Grundfos direct sensor is connected to the system.
3. In order to activate VFS Grundfos sensor to measure the thermal energy, firstly, under FS/GFDS menu to activate VFS (VFS ON), and select a measuring range (default measuring range is 1-12L/min)
4. Under FTYP menu to set flow rate type 2 (VFS)

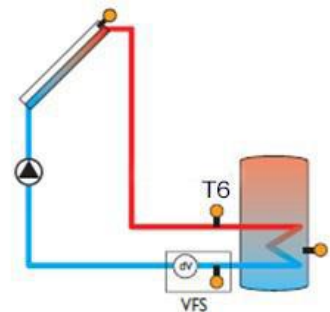

Under menu MEDT and MED% to set the anti-frozen type and concentration of fluid medium

T6: temperature on flow pipe

TVFS: temperature on return pipe

If VFS is not connected,   will blink on the screen.

● **Thermal energy measuring with rotated flow sensor FRT**

Under FTYP menu to set flow rate type 3 (FRT)

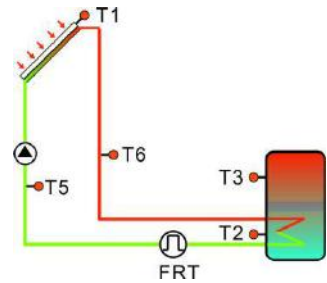

Controller calculates thermal energy used parameters value from sensor T6 on flow pipe, sensor T5 on the return pipe and flow rate which send to controller from flow sensor FRT.

Under menu MEDT and MED% to set the anti-frozen type and concentration of fluid medium



i Note:

1. Sensors on the flow and return pipe for thermal energy measuring are defaulted, not available for set.
2. Flow detecting function is available only when FRT sensor is connected to the system.
3. Under FTYP menu to set flow rate type 3 (FRT)
4. In order to activate FRT sensor to measure the thermal energy, firstly, under FS/FRT menu to activate FRT (FRT ON)

If FRT is not connected, flow monitoring function (FLOW) activated,   will blinks on the screen.

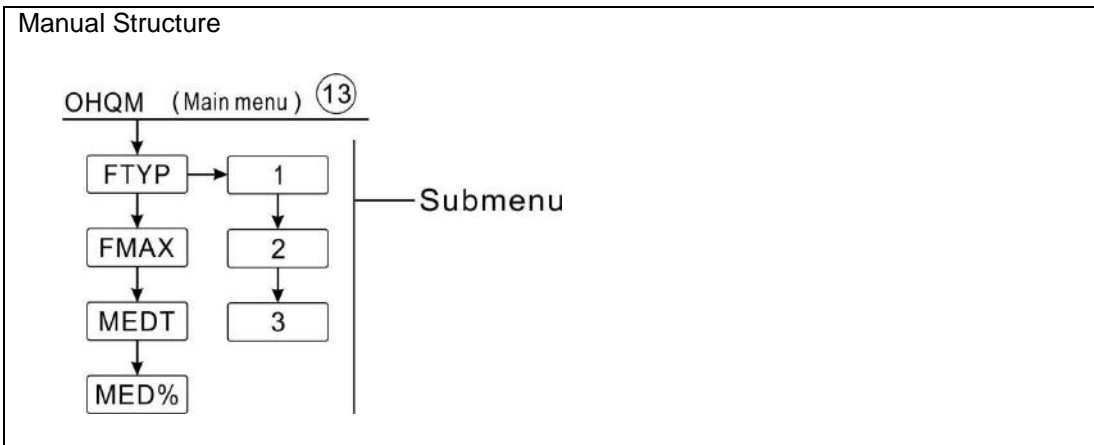

Main menu	Sub menu 1	Submenu 2	Factory set	Adjustable range	Step per adjust	Description
OHQM			OFF	ON/OFF		Thermal energy measuring
	FTYP					Type of flow meter selection

		1	1			Fixed flow meter
		2				Grundfos flow sensor(VFS)
		3				Rotated flow meter(FRT)
	FMA X		6L/min	0.5-100L/min	0.1	Flow rate enter(no this parameter if select 2 or 3 options under menu FTYP
	MED T		3	0-3		Fluid medium 0: Water 1: Propylene glycol 2: Glycol 3: Tyfocol LS/G-LS
	MED %		45%	20-70%	1%	Concentration of fluid medium

Setting function

- ▶ Select OHQM main menu
- ▶ Press “SET”, “OHQM OFF” display
- ▶ Press “SET”, “OFF” blinks
- ▶ Press “+/-”, to activate this function, “OHQM ON” displays
- ▶ Press “SET” or “ESC” to save the setting
- ▶ Press “+”, “FTYP 1” displays
- ▶ Press “SET”, “1” blinks
- ▶ Press “+/-”, to select type of flow meter
- ▶ Press “SET” or “ESC” to save the setting
- ▶ Press “+/-”, to activate this function, “OHQM ON” displays
- ▶ Press “SET” or “ESC” to save the setting
- ▶ Press “+”, “FTYP 1” displays
- ▶ Press “SET”, “1” blinks
- ▶ Press “+/-”, to select type of flow meter (1,2,3)
- ▶ Press “SET” or “ESC” to save the setting
- ▶ Press “+”, “FMAX 6” displays
- ▶ Press “SET”, “6” blinks
- ▶ Press “+/-”, to adjust value of flow meter
- ▶ Press “SET” or “ESC” to save the setting
- ▶ Press “+”, “MEDT 3” displays



- ▶ Press “SET”, “3” blinks
- ▶ Press “+/-”, to select the fluid medium.
- ▶ Press “SET” or “ESC” to save the setting
- ▶ Press “+”, “MED% 45” displays
- ▶ Press “SET”, “45” blinks
- ▶ Press “+/-”, to adjust the concentration of fluid medium
- ▶ Press “SET” or “ESC” to save the setting

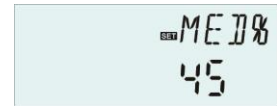



8.12 FS Flow meter option and flow rate monitoring

Under this menu, it is possible to set the on or off status of the flow meter (VFS, FRT) and set its measuring range.

FLOW (Flow monitoring) function description

Flow monitoring function is designed to detect whether flow exists in the solar system and therefore to switch-off the corresponding pump in case of no flow, It can protect system from damage, e.g. to avoid pump dry running, and it keeps the system runs properly.

If relay R1 is powered, flow rate of flow sensor will be monitored. After a delay time section (DELA), if no flow rate is detected, then solar pump R1 is ceased, and error message will appear, and at the same time sign   blinks on the screen. It may indicate that system has no fluid or pump R1 is damaged

If flow monitoring function is already activated, then tank heating is stopped until the error message is removed. If possible, when error message is solved, monitoring function will be reactivated.



Note: if VFS sensor is selected, then when error message appears, it is possible to check the reason of VFS error under check menu.

1. Checking menu L/M display “-----“, it indicates VFS function is activated, but Grundfos flow meter VFS is not connected to the controller.
2. Checking menu L/M displays “00“, it indicates VFS has no flow, it may indicate that system has no fluid or pump R1 is damaged

Manual Structure

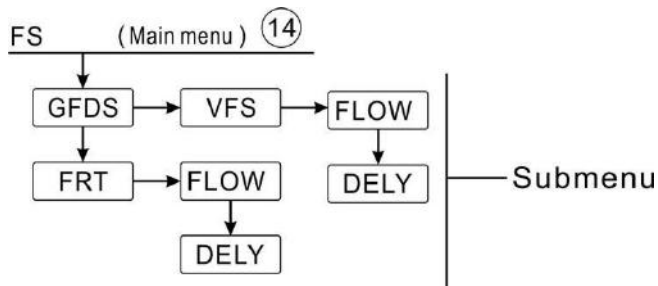

Main menu	Submenu 1	Submenu 2	Factory set	Adjustable range	Step per adjust	Description	Main menu
FS							Select flow sensor
	GFDS						
		VFS	OFF	OFF	OFF / ON		Grundfos flow sensor
			1-12				Measuring range of Grundfos flow sensor is (1-12L/Min)
			2-40				Measuring range of Grundfos flow sensor is (2-40 L/min)
		FLOW		OFF	ON/OFF		Warning when no flow
		DELY		30s	1-600s	1s	Measuring time of no flow warning
	FRT		OFF	OFF	OFF / ON		FRT flow meter
		FLOW		OFF	ON/OFF		Warning when no flow
		DELY		30s	1-600s	1s	Measuring time of no flow warning

Function setting

- ▶ Select FS main menu
- ▶ Press “SET”, “GFDS” displays
- ▶ Press “SET”, “VFS OFF” displays
- ▶ Press “+/-”, to activate this function, “VFS 1-12V” displays
- ▶ Press “+/-”, to select the measuring range of Grundfos flow meter
- ▶ Press “SET” or “ESC” to save the setting
- ▶ Press “+”, “FLOW OFF” displays
- ▶ Press “SET”, “OFF” blinks on the screen
- ▶ Press “+/-”, to activate this function, “FLOW ON” displays
- ▶ Press “SET” or “ESC” to save the setting
- ▶ Press “+”, “DELY 30” displays
- ▶ Press “SET”, “30” blinks on the screen
- ▶ Press “+/-”, to adjust the warning time of no flow
- ▶ Press “SET” or “ESC” to save the setting
- ▶ Press “ESC” to return to up menu
- ▶ Press “+”, “FRT” displays
- ▶ Press “SET”, “FRT OFF” blinks on the screen
- ▶ Press “SET”, “OFF” blinks on the screen
- ▶ Press “+/-”, to activate this function, “FRT ON” displays
- ▶ Press “SET” or “ESC” to save the setting
- ▶ Press “+”, “FLOW OFF” displays, same operation like above steps.



8.13 UNIT Switch

Under this menu, below unit can be set:

TEMP temperature

ENEG thermal energy: 1 represents KWH, 2 represents BTU

Unit of temperature can be switched between Celsius and Fahrenheit and done during normal system running.

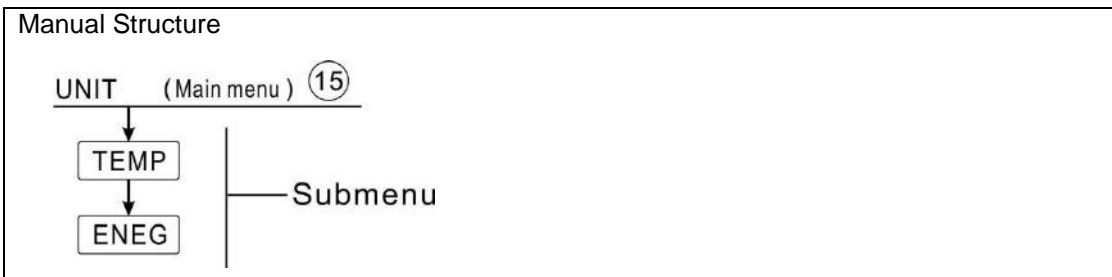

Main menu	Sub menu	Factory set	Adjustable range	Description
UNIT				Unit Switch
	TEMP	°C	°C/°F	°C-°F switch
	ENEG	1(Wh)	1(Wh) /2(BTU)	Thermal energy unit switch

Function setting

- ▶ Select UNIT menu
- ▶ Press “SET”, “TEMP °C” displays on the screen
- ▶ Press “SET”, “°C” blinks
- ▶ Press “+/-”, to select temperature unit
- ▶ Press “SET” or “ESC” to save the setting
- ▶ Press “+”, “ENEG 1” displays
- ▶ Press “SET”, “1” blinks
- ▶ Press “+/-”, to select thermal energy unit
- ▶ Press “SET” or “ESC” to save the setting



8.14 RET Reset

RSTP (Menu parameters): through reset function, all parameters can be reset to factory setting

CHQM (accumulated thermal energy): accumulated thermal energy can be reset to 0

CRT (pump running time): accumulated pump running time (R1time) can be reset to 0

Manual structure

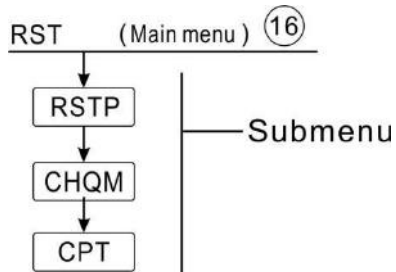

Function setting

- ▶ Select RST menu
- ▶ Press “SET”, “RSTP” displays on the screen
- ▶ Press “SET”, “YES” blinks
- ▶ Press “SET” for 3 seconds, beeper sounds “di” 3 times, “YES” lighting, and it indicates system is recovered to factory set.
- ▶ Press “ESC” return to the submenu
- ▶ Press “▲”, “CHQM” displays, and do like above step to reset the CHQM, CPT parameters.



8.15 PASS Password set

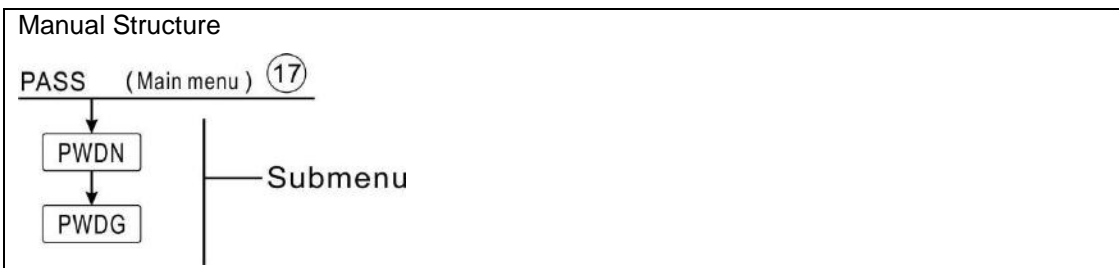

Function Setting

Select PASS main menu,

- ▶ Press “SET” button, “PWDN 0000” displays on the screen,
- ▶ Press “SET” button again, the left first digital blinks, ask for entering the new password
- ▶ Press “+/-” button, to enter the first digital.
- ▶ Press “SET” button again, the second digital blinks
- ▶ Press “+/-” button, to enter the second digital.
- ▶ Press “SET” button again, the third digital blinks
- ▶ Press “+/-” button, to enter the third digital.
- ▶ Press “SET” button again, the forth digital blinks
- ▶ Press “+/-” button, to enter the forth digital.
- ▶ Press “SET” button again, “PWDG 0000” displays on the screen, to enter the new password again, after confirm the new password, “ OK” displays on the screen, it indicates the new password setting successfully.



Note: If the password is forgot, it is impossible to recover, but you can recover the

password to the factory set, then you can reedit a password like above descript steps, doing like following to recover to factory set.



- Switch-off the power to controller
- Hold down “ESC” button
- Reconnect the power supply, when beeper sounds 3 di di di, and then release “ESC” button, Controller recovers to the factory set password (factory set password is 0000),

8.16 Manual heating

Function Description:

It is possible to trigger back-up heating manually with this controller to heat tank. When tank temperature is lower than the set point of the switch-on temperature of this function, manual heating function is in standby, then when you press the manual heating button, heating will start, and it works until tank temperature reaches to the set point.

Activate/deactivate this function:

- ▶ Press “Manual Heating” button, temperature “60°C” blinks on the screen
- ▶ Press “+/-” button to adjust the desired temperature, adjustable range 10°C~80°C, factory set is 60°C
- ▶ Press “Manual Heating” or “ESC” or waiting for 20 seconds to trigger the manual heating, then manual sign  displays on the screen, heating sign  blinks the screen
- ▶ Press “Manual Heating” again, switch-off the manual heating.

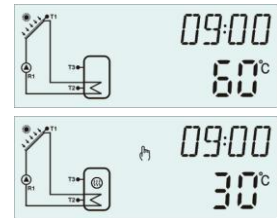



i **Note:** Manual heating is not a continuous heating process, it is triggered manually, and when the temperature reaches to the set point, the heating process is stopped. And manual heating function is stopped automatically.

8.17 ECO Economic mode

Function description:



Under the ECO economic mode, timing heating and intelligent heating functions are switched-off, only manual heating mode (M.H) can be used to trigger the electrical heater.

Activate/deactivate this function:

- ▶ Press “ECO Mode” button, sign  displays, it indicates Eco mode is on.
- ▶ Press “ECO Mode” button again, sign  closed, it indicates the ECO mode is off.



8.18 DHW circuit pump triggered manually

i **Note:** Only when function of DHW circuit pump CIRC is activated, it is just possible to trigger the output R2 manually for running the DHW circuit pump. (Default pump runs for 3 minutes)

- ▶ Press “” one time, to trigger the DHW circuit pump R2
- ▶ Press “” again, to cease the manual output.

8.19 On/Off controller



Under the on status

- ▶ Press  button for 3 seconds; controller is switched-off, “OFF” shows on the screen.
- ▶ Re-press  button again, controller restarted.

8.20 Holiday function

The holiday function is used for operating the system when no water consumption is expected, e. g. during a holiday absence. This function cools down the system in order to reduce the thermal load.

Activate/deactivate this function:

- ▶ Press “Holiday” button for 3 seconds, “HDAY 05” displays on the screen
- ▶ Press “+/-”, to adjust holiday’s days, adjustable range 0-99 days
- ▶ Press “ESC” to save set, holiday function is activated and holiday sign  displayed and lighted.
- ▶ After holiday function is activated, and then press “Holiday” button to cease this function, holiday sign  displayed but not lighted.

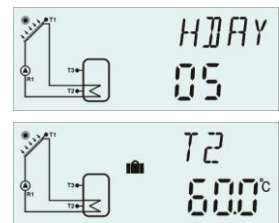

i **Note:** When you return from holiday, please deactivate this function in time.

8.21 Manual circuit function

- ▶ Press “Manual Circuit” button, circuit pump R1 is triggered and runs for 1 hour.

► Press “Manual Circuit” button, to switch- off the circuit pump R1.

During the running of circuit pump R1, if you don't press “Manual circuit” button, then R1 will run for 1 hour, then it is stopped automatically. And manual circuit function is deactivated correspondingly.

9. Protection function

9.1 Memory function during power failure

When power of controller is failed, and when power is switched-on, controller will keep the parameters which set before power failure.

9.2 Screen protection

When no any press on button for 5 minutes, screen protection is activated automatically, and then LED background lamp is switched-off. Through press any button to light LED lamp again.

10 Trouble checking

The built-in controller is a qualified product, which is conceived for years of continuous trouble-free operation. If a problem occurs, the most of causes is from the peripheral components but no relation with controller itself. The following description of some well-known problems should help the installer and operator to isolate the problem, so that the system can be put into operation as quickly as possible and to avoid unnecessary cost. Of course, not all possible problems can be listed here. However, most of the normal problems encountered with the controller can be found in the list below, only return the controller to seller when you are absolutely sure that none of the problems listed below is responsible for the fault.

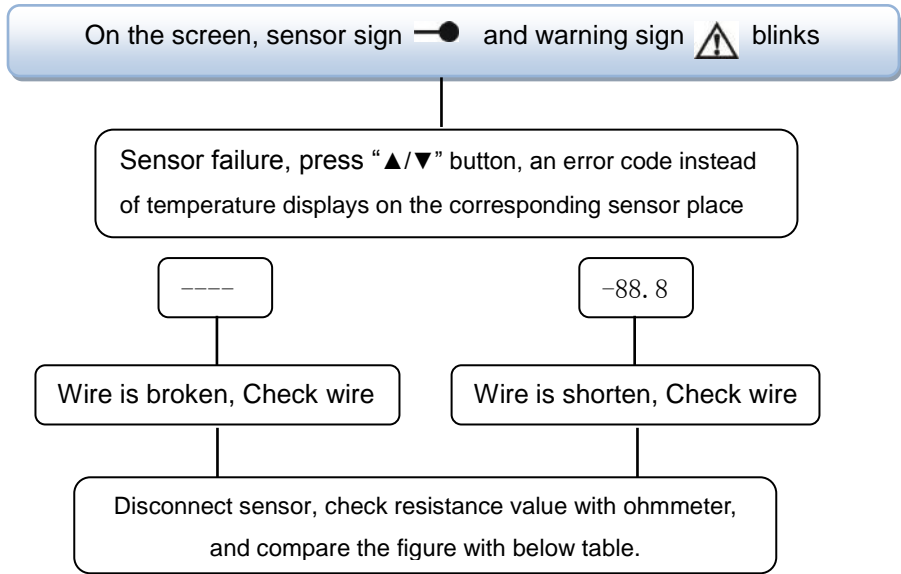

PT1000 resistance value

℃	0	10	20	30	40	50	60	70	80	90	100	110	120
Ω	1000	1039	1077	1116	1155	1194	1232	1270	1309	1347	1385	1422	1460

NTC 10K B=3950 resistance value

℃	0	10	20	30	40	50	60	70	80	90	100	110	120
Ω	33620	20174	12535	8037	5301	3588	2486	1759	1270	933	697	529	407

Error Code Explanation

Error code	Meaning	Reasons and solution
E0	Communication fault between display and controller	1. White wire broken or not well connected. 2. Communication fault of display or controller
SMAX---/T3--- alternately displays	Sensor of tank maximum temperature (SMAX) is set to T3 or sensor fault	1. Under main menu (load)to select T2 sensor used for the tank maximum temperature function(SMAX) 2. T3 on upper part of tank is not installed 3. T3 sensor is damaged.
THS---/T3--- alternately	Sensor of heating object (THS)is set to T3 or	1. Under main menu (THET) to select sensor T2 used for the objective sensor.



displays	sensor fault	2. T3 on upper part of tank is not installed 3. T3 sensor is damaged.
AHS---/T3--- alternately displays	Sensor of thermostat function (AHS)is set to T3 or sensor fault	1. Under submenu AH of auxiliary function menu (AUX) to select sensor T2 used for the thermostat sensor 2. T3 on upper part of tank is not installed 3. T3 sensor is damaged.



11. Quality Guarantee

Manufacturer provides following quality responsibilities to end-users: within the period of quality responsibilities, manufacturer will exclude the failure caused by production and material selection. A correct installation will not lead to failure. When a user takes incorrect handling way, incorrect installation, improper or crude handling, and wrong connection of Warm water outflow upwards, we don't take the responsibilities caused by before mentioned actions.

The quality warranty expires within 18 months after the date of purchasing the controller.

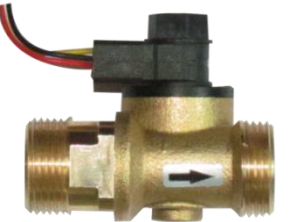
12. Accessories

Products name	Specification	Products picture
A01: High accurate Pt1000 sensor for collector	PT1000, $\Phi 6 \times 50$ mm,with 1.5m cable	
A02 High accurate sensor for tank and pipe	NTC10K, B=3950, $\Phi 6 \times 50$ mm,with 3m cable	
A05 304 stainless steel thermo well	304 stainless steel with thread 1/2' OT, Size: $\Phi 8 \times 200$	
Digital flow meter FRT (A17) Parameter: thread male 3/4		

<p>A13 Grundfos Direct Sensor VFS</p>	<p>1-12l/min; 2-40l/min</p>	
<p>SR802 Unit for high power electrical heater</p>	<p>Dimension:100mm*100mm*65mm Power supply: AC180V ~ 264V, 50/60Hz Suitable power: ≤ 4000W Available ambient temperature: -10 ~ 50°C Waterproof grade: IP43</p>	

● SR802 connection diagram

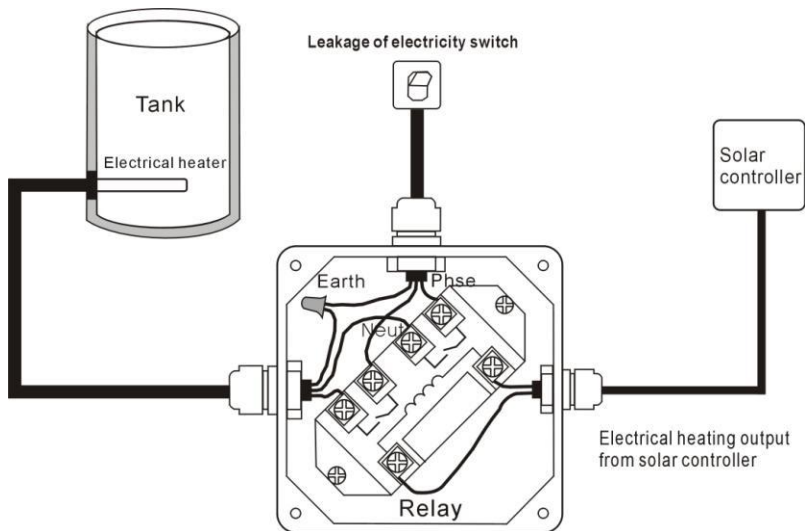

Note: Switch-off power, and perform by profession installer.